

## Ultra-Fast Recovery Rectifier Diodes

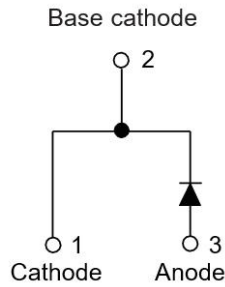
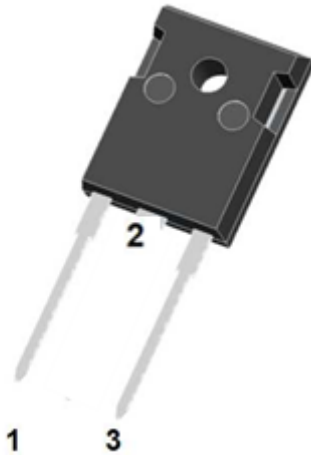

### Features

- High frequency operation
- High surge forward current capability
- High purity, high temperature epoxy encapsulation for enhanced mechanical strength and moisture resistance
- Guard ring for enhanced ruggedness and long term reliability
- Solder dip 275 °C max. 7 s, per JESD 22-B106

### Typical Applications

Typical applications are in switching power supplies, converters, freewheeling diodes, and reverse battery protection.

### Mechanical Data

- **Package:** TO-247AC  
Molding compound meets UL 94 V-0 flammability rating, RoHS-compliant
- **Terminals:** Tin plated leads, solderable per J-STD-002 and JESD22-B102
- **Polarity:** As marked

### ■ Maximum Ratings ( $T_j=25^\circ\text{C}$ Unless otherwise specified)

PARAMETER	SYMBOL	UNIT	MUR7560PL
Device marking code			MUR7560PL
Repetitive Peak Reverse Voltage	$V_{RRM}$	V	600
Average Rectified Output Current @60Hz half sine-wave, R-load, $T_c$ (FIG.1)	$I_o$	A	75
Surge(Non-repetitive)Forward Current @60Hz half sine-wave, 1 cycle, $T_j=25^\circ\text{C}$	$I_{FSM}$	A	500
Current Squared Time @1ms≤t≤8.3ms $T_j=25^\circ\text{C}$	$I^2t$	A <sup>2</sup> s.	1037
Storage Temperature	$T_{stg}$	°C	-55 ~ +175
Junction Temperature	$T_j$	°C	-55 ~ +175
Typical Junction capacitance @4V,1MHz	$C_j$	pF	200



# MUR7560PL

## ■Electrical Characteristics (T<sub>j</sub>=25°C Unless otherwise specified)

PARAMETER	SYMBOL	UNIT	TEST CONDITIONS	Min	Typ	Max
instantaneous forward voltage drop per diode	V <sub>FM</sub>	V	I <sub>FM</sub> =75.0A T <sub>j</sub> =25°C	-	2.0	2.75
DC reverse current at rated DC blocking voltage per diode	I <sub>RRM1</sub>	uA	V <sub>RM</sub> =V <sub>RRM</sub> T <sub>j</sub> =25°C	-	-	5.0
	I <sub>RRM2</sub>		V <sub>RM</sub> =V <sub>RRM</sub> T <sub>j</sub> =125°C	-	-	200
Reverse Recovery Time	T <sub>rr</sub>	ns	I <sub>F</sub> =0.5A I <sub>RM</sub> =1A I <sub>RR</sub> =0.25A T <sub>j</sub> =25°C	-	35	50
			T <sub>j</sub> =25°C	-	47	-
			T <sub>j</sub> =125°C	-	61	-
Peak recovery current	I <sub>RRM</sub>	A	T <sub>j</sub> =25°C	-	13.37	-
			T <sub>j</sub> =125°C	-	29.27	-
Reverse recovery charge	Q <sub>rr</sub>	nC	T <sub>j</sub> =25°C	-	280	-
			T <sub>j</sub> =125°C	-	1270	-

## ■Thermal Characteristics (T<sub>j</sub>=25°C Unless otherwise specified)

PARAMETER		SYMBOL	UNIT	MUR7560PL
Thermal Resistance	Between junction and case	R <sub>θJ-C</sub>	°CW	0.4
	Between junction and Air	R <sub>θJ-A</sub>	°CW	45

## ■Ordering Information (Example)

PREFERRED P/N	UNIT WEIGHT(g)	MINIMUM PACKAGE(pcs)	INNER BOX QUANTITY(pcs)	OUTER CARTON QUANTITY(pcs)	DELIVERY MODE
MUR7560PL	Approximate 6.0	30	360	1800	Tube

## ■Characteristics (Typical)

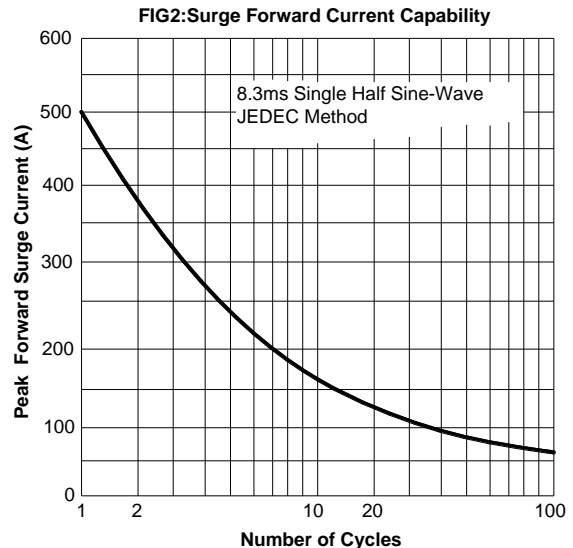
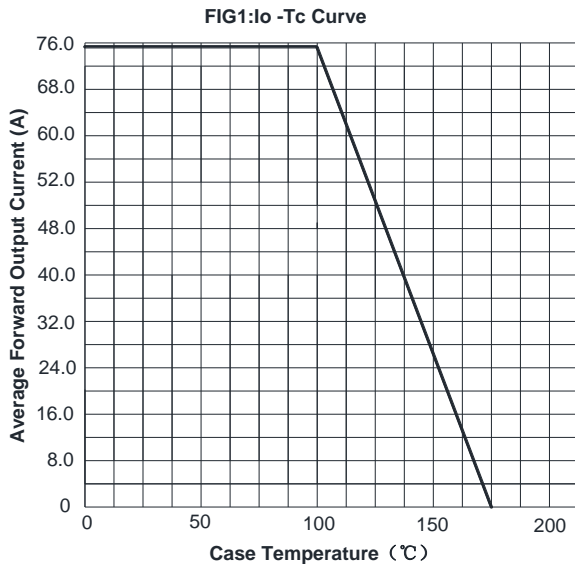



# MUR7560PL

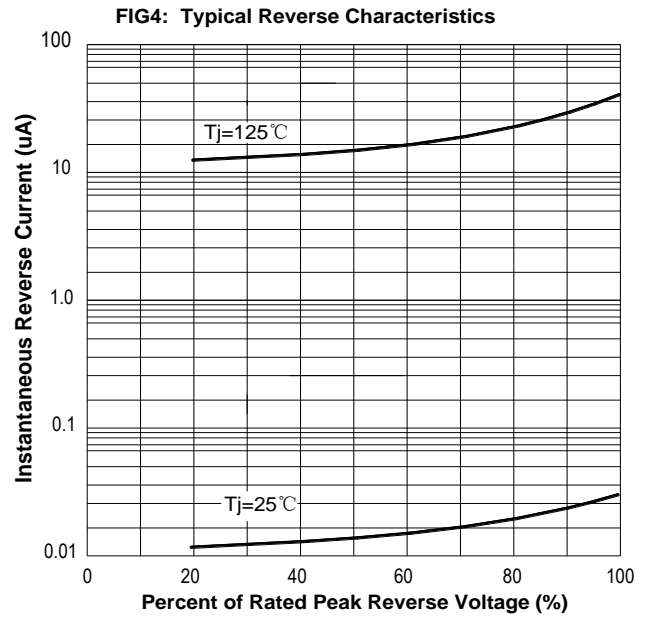
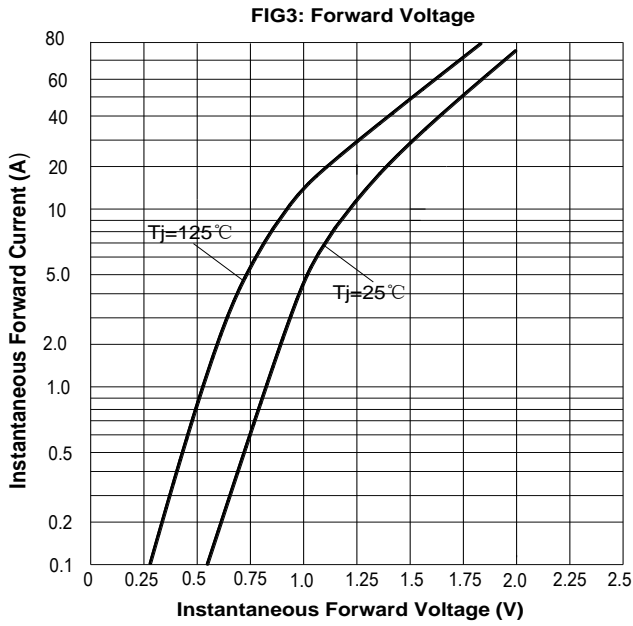

**FIG.5 Diagram of circuit and Testing wave form of reverse recovery time**

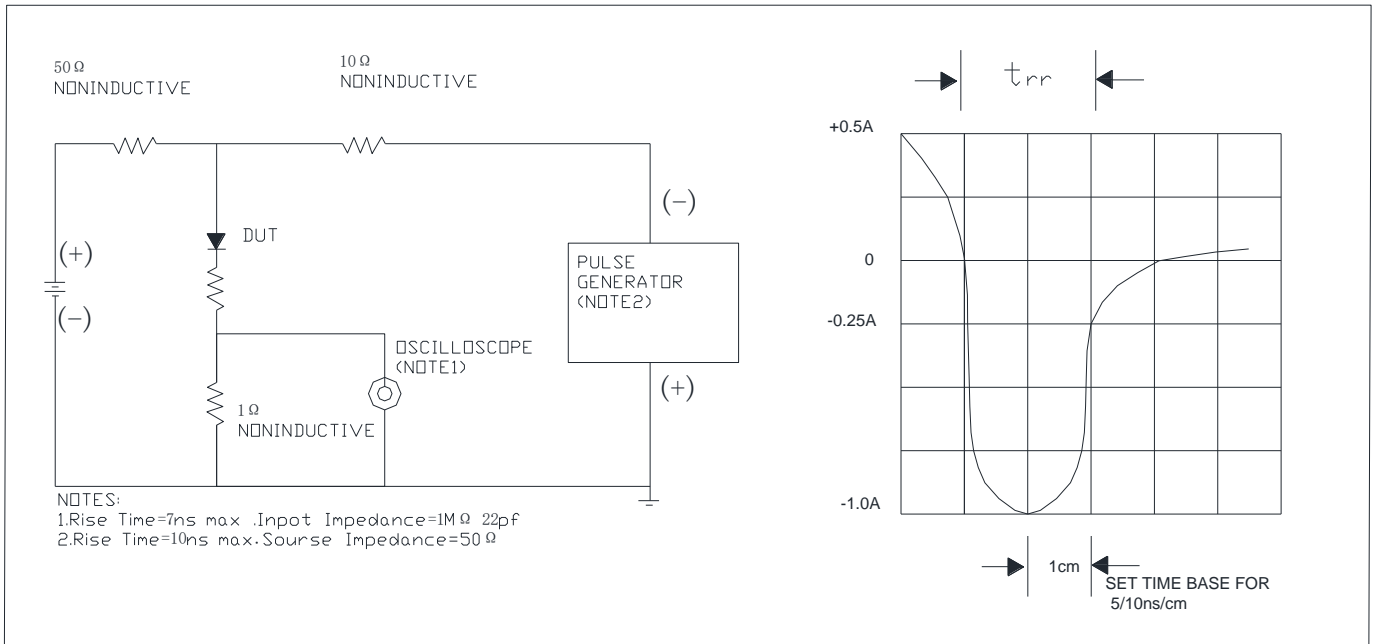



# MUR7560PL

## ■Outline Dimensions

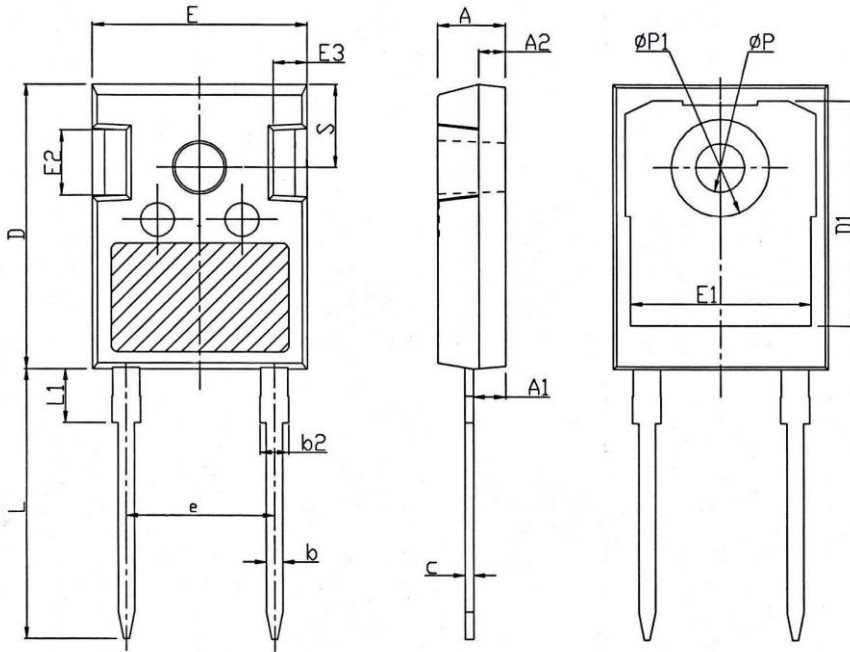

TO-247AC		
Dim	Min	Max
A	4.80	5.20
A1	2.21	2.61
A2	1.85	2.15
b	1.11	1.36
b2	1.91	2.21
c	0.51	0.75
D	20.70	21.30
D1	16.25	16.85
E	15.50	16.10
E1	13.00	13.60
E2	4.80	5.20
E3	2.30	2.70
e	10.88BSC	
L	19.62	20.22
L1	-	4.30
$\phi P$	3.40	3.80
$\phi P1$	-	7.30
S	6.15BSC	



## MUR7560PL

---

### Disclaimer

The information presented in this document is for reference only. Yangzhou Yangjie Electronic Technology Co., Ltd. reserves the right to make changes without notice for the specification of the products displayed herein to improve reliability, function or design or otherwise.

The product listed herein is designed to be used with ordinary electronic equipment or devices, and not designed to be used with equipment or devices which require high level of reliability and the malfunction of which would directly endanger human life (such as medical instruments, transportation equipment, aerospace machinery, nuclear-reactor controllers, fuel controllers and other safety devices), Yangjie or anyone on its behalf, assumes no responsibility or liability for any damages resulting from such improper use of sale.

This publication supersedes & replaces all information previously supplied. For additional information, please visit our website [http:// www.21yangjie.com](http://www.21yangjie.com) , or consult your nearest Yangjie's sales office for further assistance.