

Ultra-Fast Recovery Diodes 10A FRED

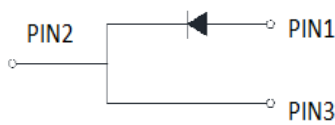

Features

- Adopt FRED chip
- Low forward Voltage drop
- Fast reverse recovery time
- High frequency operation
- High purity, high temperature epoxy encapsulation for enhanced mechanical strength and moisture resistance
- Guard ring for enhanced ruggedness and long term reliability

Typical Applications

Typical applications are in switching power supplies, converters, freewheeling diodes, and reverse battery protection.

Mechanical Data

- **Package:** TO-220AC
Molding compound meets UL 94 V-0 flammability rating, RoHS-compliant
- **Terminals:** Tin plated leads, solderable per J-STD-002 and JESD22-B102
- **Polarity:** As marked

■Maximum Ratings (T_j=25°C Unless otherwise specified)

PARAMETER	SYMBOL	UNIT	MUR1040
Device marking code			MUR1040
Repetitive Peak Reverse Voltage	V _{RRM}	V	400
Average Rectified Output Current @60Hz sine wave, R-load, T _c (FIG.1)	I _o	A	10
Surge(Non-repetitive)Forward Current @60Hz half sine-wave, 1 cycle, T _j =25°C	I _{FSM}	A	120
Current Squared Time @1ms≤t≤8.3ms T _j =25°C.	I ² t	A ² s	60
Storage Temperature	T _{stg}	°C	-55 ~ +175
Junction Temperature	T _j	°C	-55 ~ +175
Typical Junction capacitance @4V,1MHz	C _j	pF	50



MUR1040-B1-W5094HF

■Electrical Characteristics

PARAMETER	SYMBOL	UNIT	TEST CONDITIONS	Min	Typ	Max	
Instantaneous forward voltage drop per diode	V_{FM}	V	$I_{FM}=10.0A @T_j=25^{\circ}C$	-	1.15	1.30	
			$I_{FM}=10.0A @T_j=150^{\circ}C$		0.9	1.0	
DC reverse current at rated DC blocking voltage per diode	I_{RRM1}	uA	$V_{RM}=V_{RRM}$ $T_j=25^{\circ}C$	-	-	5	
	I_{RRM2}		$V_{RM}=V_{RRM}$ $T_j=150^{\circ}C$	-	40	100	
Reverse Recovery Time	T_{RR}	ns	$I_F=0.5A$ $I_{RM}=1A$ $I_{RR}=0.25A$ $T_j=25^{\circ}C$	-	25	35	
			$T_j=25^{\circ}C$	-	30	-	
			$T_j=125^{\circ}C$	-	50	-	
Peak recovery current	I_{RRM}	A	$T_j=25^{\circ}C$	$I_F=10A$ $di/dt=-200A/us$ $V_{RM}=200V$	-	3.3	-
			$T_j=125^{\circ}C$		-	6.8	-
Reverse recovery charge	Q_{rr}	nC	$T_j=25^{\circ}C$		-	50	-
			$T_j=125^{\circ}C$		-	170	-

■Thermal Characteristics ($T_j=25^{\circ}C$ Unless otherwise specified)

PARAMETER		SYMBOL	UNIT	MUR1040
Thermal Resistance	Between junction and case	$R_{\theta J-C}$	$^{\circ}C/W$	2.0
	Between junction and Air	$R_{\theta J-A}$	$^{\circ}C/W$	50

■Ordering Information (Example)

PREFERRED P/N	UNIT WEIGHT(g)	MINIMUM PACKAGE(pcs)	INNER BOX QUANTITY(pcs)	OUTER CARTON QUANTITY(pcs)	DELIVERY MODE
MUR1040	Approximate 1.8	50	1000	5000	Tube



MUR1040-B1-W5094HF

■ Characteristics (Typical)

FIG1: I_o - T_c Curve

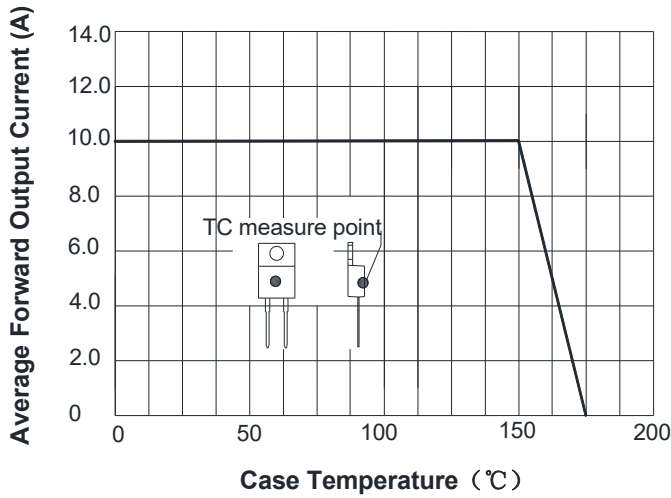

FIG2: Surge Forward Current Capability

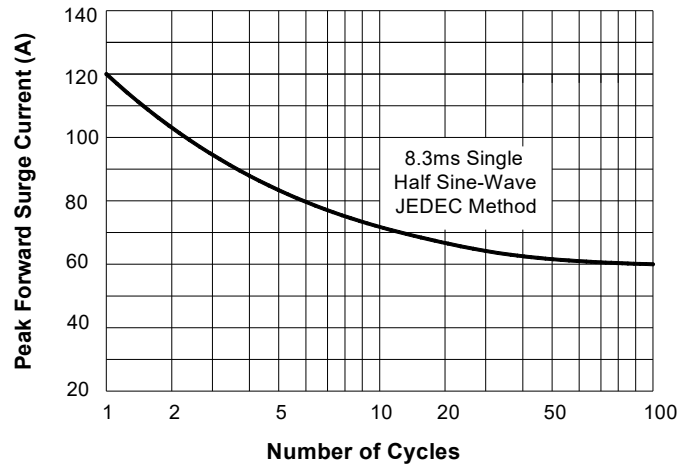

FIG3: Forward Voltage

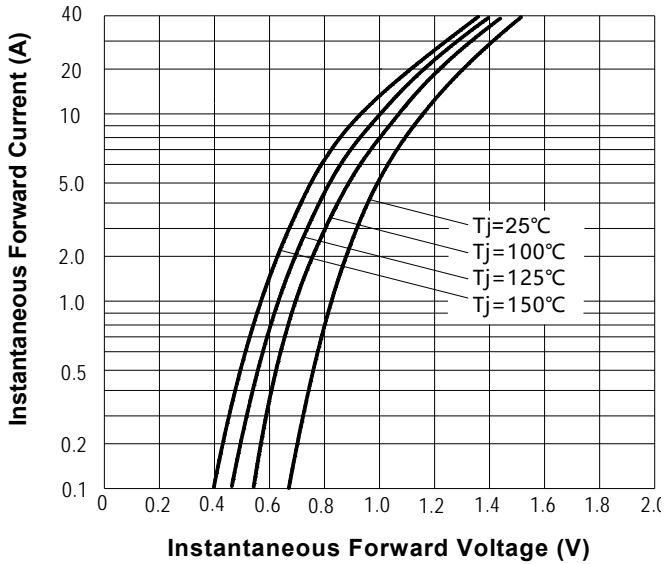

FIG4: Instantaneous Reverse Characteristics

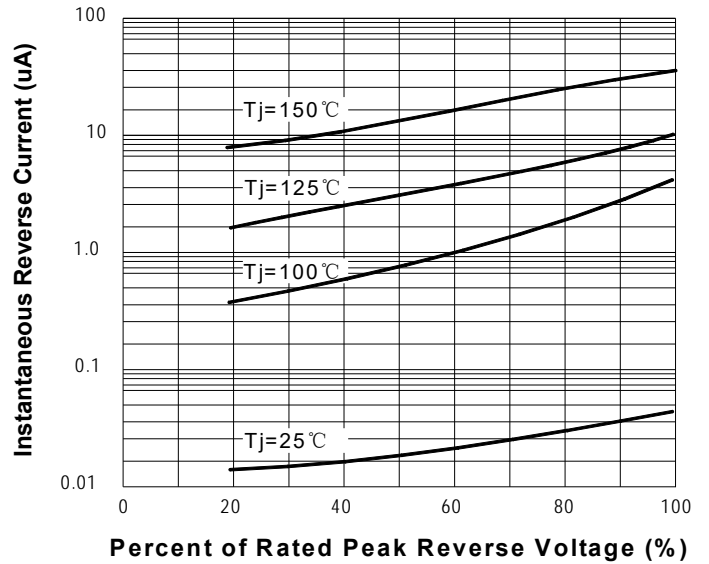
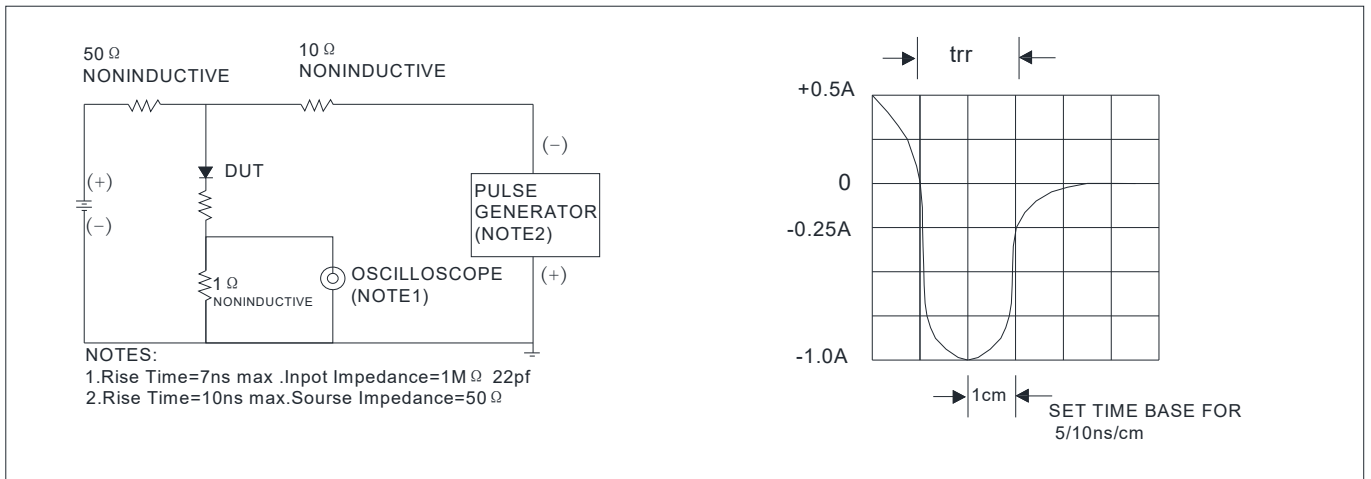

FIG5: Diagram of circuit and Testing wave form of reverse recovery time





MUR1040-B1-W5094HF

■Outline Dimensions

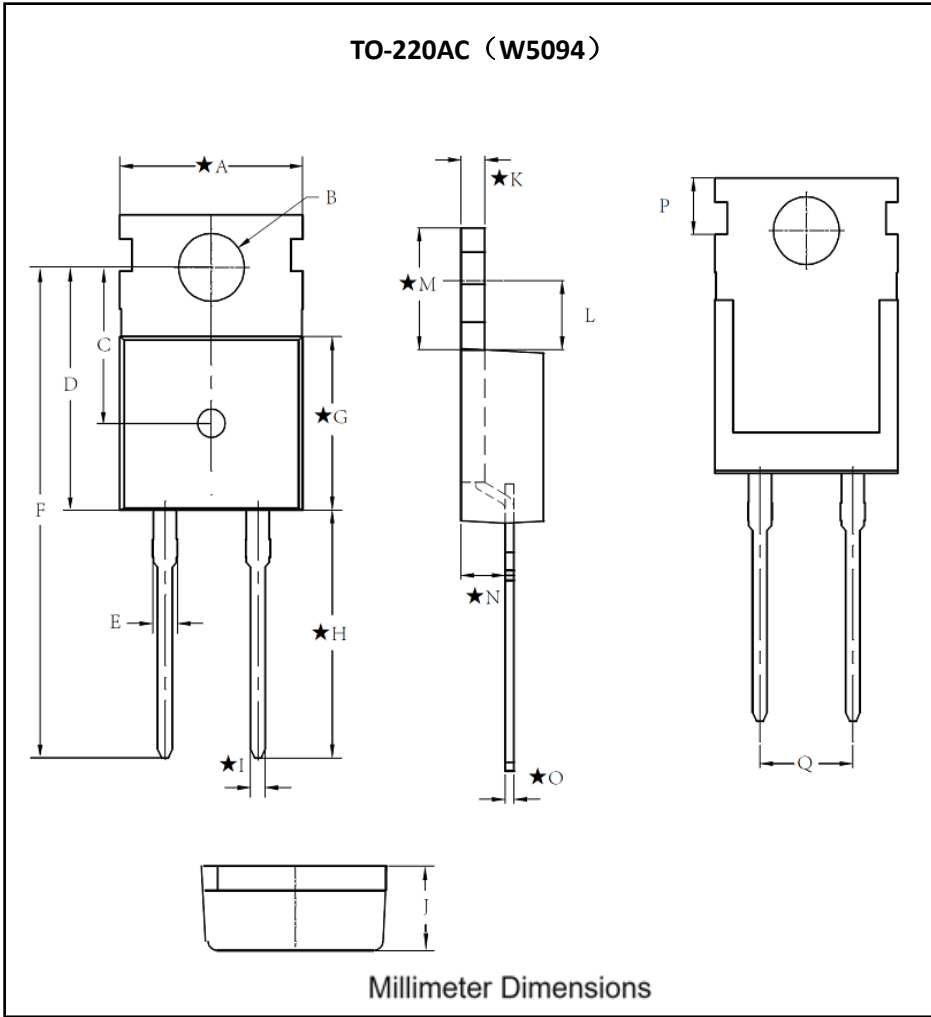

TO-220AC		
Dim	Min	Max
A	9.9	10.1
B	TYP 3.6	
C	8.06	8.46
D	12.67	13.07
E	1.28	1.42
F	25.7	26.3
G	9.0	9.4
H	12.93	13.33
I	TYP 0.8	
J	4.3	4.7
K	1.285	1.315
L	3.47	3.87
M	6.27	6.67
N	2.2	2.6
O	0.485	0.515
P	2.8	3.2
Q	TYP 5.08	



MUR1040-B1-W5094HF

Disclaimer

The information presented in this document is for reference only. Yangzhou Yangjie Electronic Technology Co., Ltd. reserves the right to make changes without notice for the specification of the products displayed herein to improve reliability, function or design or otherwise.

The product listed herein is designed to be used with ordinary electronic equipment or devices, and not designed to be used with equipment or devices which require high level of reliability and the malfunction of which would directly endanger human life (such as medical instruments, transportation equipment, aerospace machinery, nuclear-reactor controllers, fuel controllers and other safety devices), Yangjie or anyone on its behalf, assumes no responsibility or liability for any damages resulting from such improper use of sale.

This publication supersedes & replaces all information previously supplied. For additional information, please visit our website [http:// www.21yangjie.com](http://www.21yangjie.com) , or consult your nearest Yangjie's sales office for further assistance.