

## Silicon Carbide Schottky Diode

$V_{RRM}$	1200V
$I_F (135^\circ\text{C})$	90A <sup>(2)</sup>
$Q_C$	422nC <sup>(2)</sup>

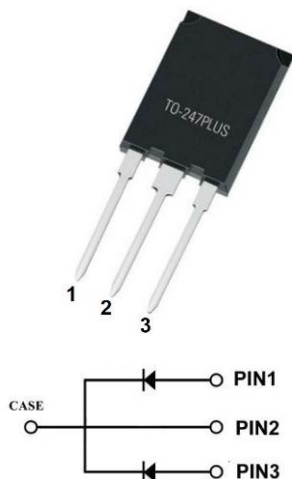

### Features

- Positive temperature coefficient
- Temperature-independent switching
- Maximum working temperature at 175 °C
- Unipolar devices and zero reverse recovery current
- Zero forward recovery current
- Essentially no switching losses
- Reduction of heat sink requirements
- High-frequency operation
- Reduction of EMI

### Typical Applications

Typical applications are in power factor correction(PFC), solar inverter, uninterruptible power supply, motor drives, photovoltaic inverter, electric car and charger.

### Mechanical Data

- **Package:** TO-247PLUS  
Molding compound meets UL 94 V-0 flammability rating, RoHS-compliant, halogen-free
- **Terminals:** Tin plated leads
- **Polarity:** As marked

### ■Maximum Ratings ( $T_C=25^\circ\text{C}$ Unless otherwise specified)

PARAMETER	SYMBOL	UNIT	VALUE
Device marking code			D112080NPQG2
Reverse voltage (Repetitive peak) @ $T_j=25^\circ\text{C}$	$V_{RRM}$	V	1200
Reverse voltage (Surge peak) @ $T_j=25^\circ\text{C}$	$V_{RSM}$	V	1200
Reverse voltage (DC) @ $T_j=25^\circ\text{C}$	$V_{DC}$	V	1200
Continuous forward current @ $T_C=25^\circ\text{C}$	$I_F$	A	98/196
Continuous forward current @ $T_C=135^\circ\text{C}$			45/90
Continuous forward current @ $T_C=143^\circ\text{C}$			40/80
Non-repetitive peak forward surge current @ $T_C=25^\circ\text{C}$ , $t_p=10\text{ms}$ , Half Sine Wave	$I_{FSM}$	A	300 <sup>(1)</sup>
Power Dissipation@ $T_C=25^\circ\text{C}$	$P_{TOT}$	W	375/750
Power Dissipation@ $T_C=110^\circ\text{C}$			162/325
$i^2t$ Value@ $T_C=25^\circ\text{C}$ , $t_p=10\text{ms}$	$\int i^2 dt$	A <sup>2</sup> S	450 <sup>(1)</sup>
Operating junction and Storage temperature range	$T_j, T_{stg}$	°C	-55 to +175

(1) Per Leg, (2) Per Device



## ■Electrical Characteristics (Per Leg)

PARAMETER	SYMBOL	UNIT	TEST CONDITIONS	Typ.	Max.
Forward voltage drop	$V_F$	V	$I_F=40A, T_j=25^{\circ}C$	1.42	1.58
			$I_F=40A, T_j=175^{\circ}C$	2.02	-
Reverse leakage current	$I_R$	$\mu A$	$V_R=1200V, T_j=25^{\circ}C$	1	12
			$V_R=1200V, T_j=175^{\circ}C$	10	-
Total capacitive charge	$Q_C$	nC	$V_R=800V, T_j=25^{\circ}C, Q_C=\int_0^{V_R} C(V)dV$	211	-
Total capacitance	C	pF	$V_R=0V, f=1MHZ$	3010	-
			$V_R=400V, f=1MHZ$	198	-
			$V_R=800V, f=1MHZ$	155	-
Capacitance Stored Energy	$E_C$	$\mu J$	$V_R=800V$	55	-

## ■Thermal Characteristics ( $T_a=25^{\circ}C$ Unless otherwise specified)

PARAMETER	SYMBOL	UNIT	VALUE
Thermal resistance	$R_{\theta J-C}$	$^{\circ}C/W$	0.4 <sup>(1)</sup> 0.2 <sup>(2)</sup>

(<sup>1</sup>) Per Leg, (<sup>2</sup>) Per Device

## ■Typical Characteristics (Per Leg)

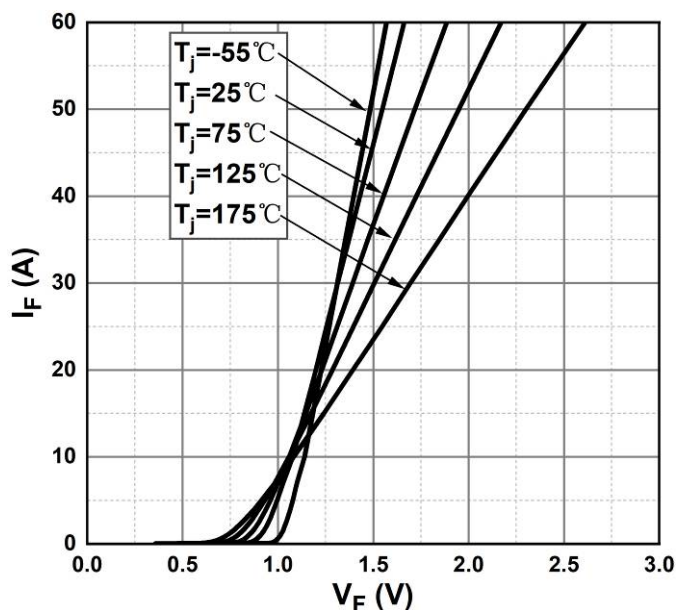

Figure 1. Forward Characteristics

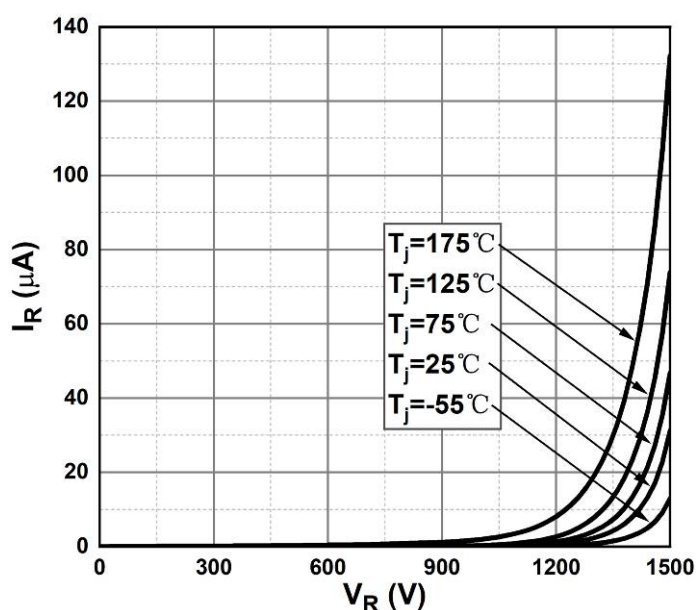

Figure 2. Reverse Characteristics

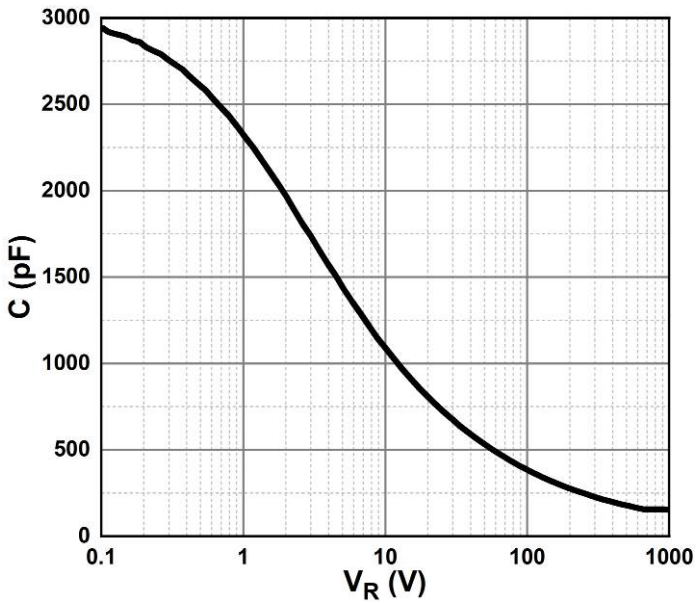

Figure 3. Capacitance vs. Reverse Voltage

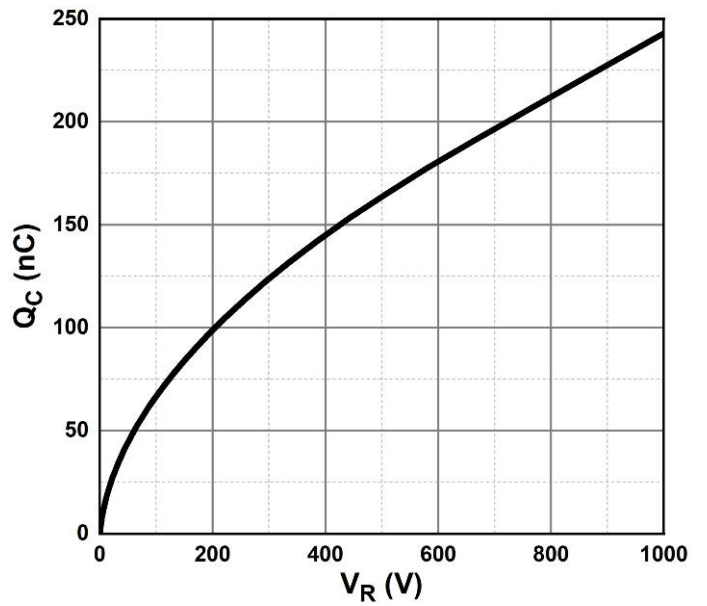

Figure 4. Total Capacitance Charge vs. Reverse Voltage

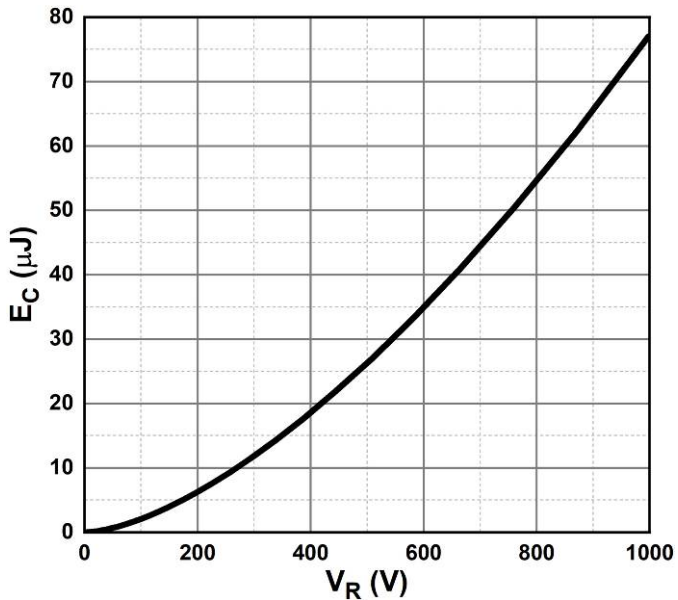

Figure 5. Capacitance Stored Energy

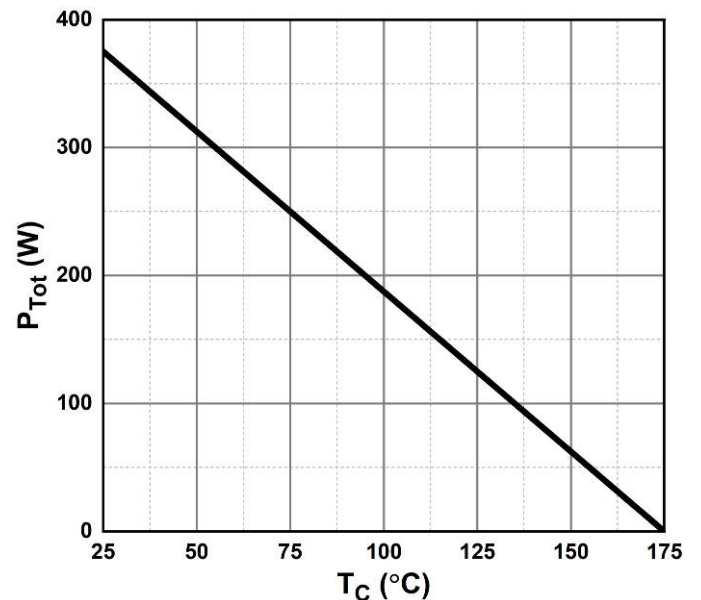

Figure 6. Power Derating

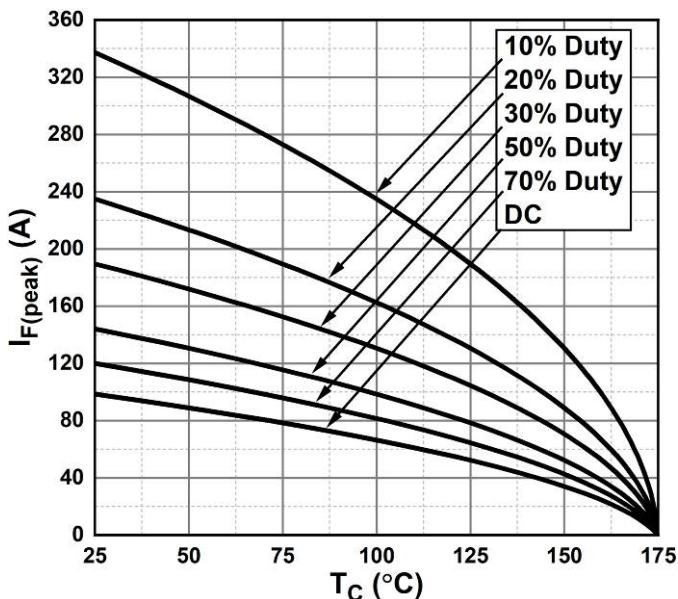

Figure 7. Current Derating



■ Typical Characteristics (Device)

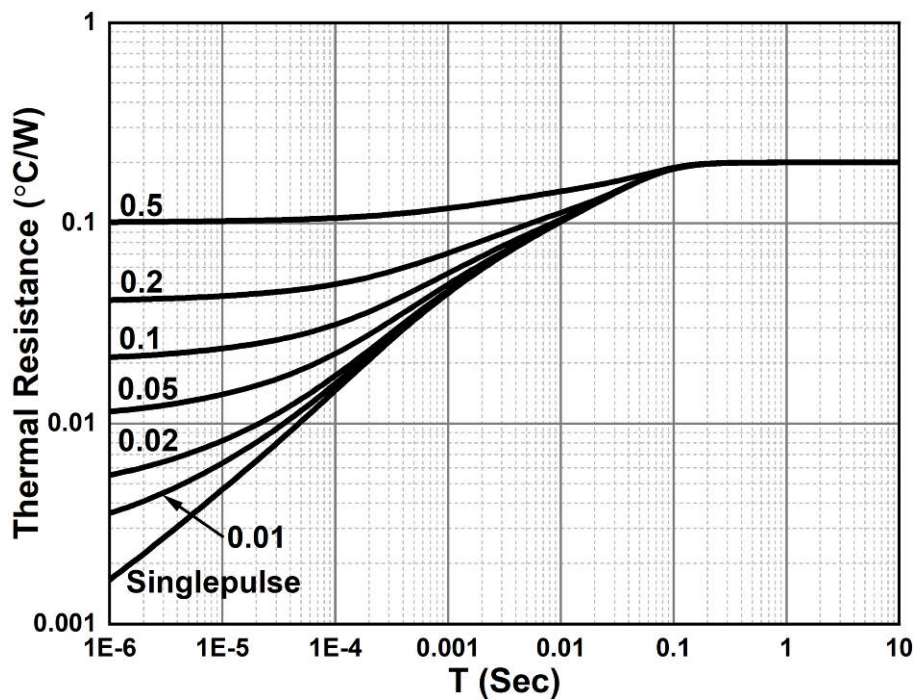
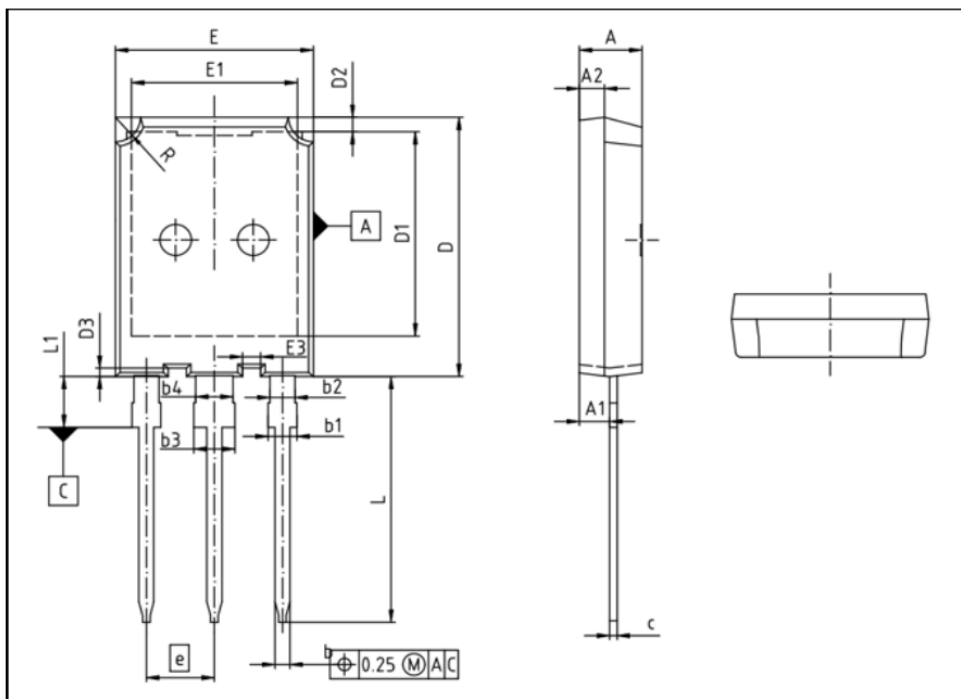

Figure 8. Transient Thermal Impedance

## ■Outline Dimensions

### TO-247PLUS



DIM	MILLIMETERS	
	MIN	MAX
A	4.90	5.10
A1	2.31	2.51
A2	1.90	2.10
b	1.16	1.26
b1	1.86	2.16
b2	1.96	2.06
c	0.58	0.64
D	20.90	21.10
D1	16.25	16.85
D2	1.05	1.35
D3	0.58	0.78
E	15.70	15.90
E1	13.10	13.50
E3	1.35	1.55
e	5.44(BSC)	
L	19.78	20.08
L1	4.03	4.23
R	1.90	2.10



## Disclaimer

The information presented in this document is for reference only. Yangzhou Yangjie Electronic Technology Co., Ltd. reserves the right to make changes without notice for the specification of the products displayed herein to improve reliability, function or design or otherwise.

The product listed herein is designed to be used with ordinary electronic equipment or devices, and not designed to be used with equipment or devices which require high level of reliability and the malfunction of which would directly endanger human life (such as medical instruments, transportation equipment, aerospace machinery, nuclear-reactor controllers, fuel controllers and other safety devices), Yangjie or anyone on its behalf, assumes no responsibility or liability for any damages resulting from such improper use of sale.

This publication supersedes & replaces all information previously supplied. For additional information, please visit our website [http:// www.21yangjie.com](http://www.21yangjie.com) , or consult your nearest Yangjie's sales office for further assistance.