

N-Channel Enhancement Mode Field Effect Transistor

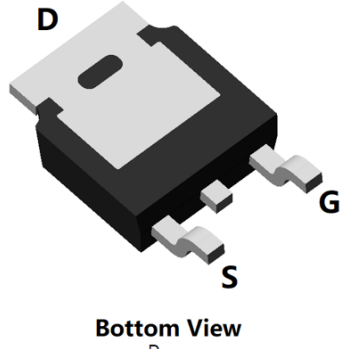

TO-252

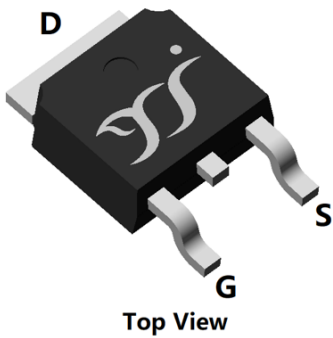
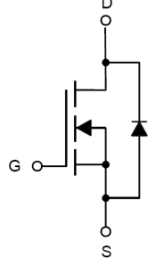

Product Summary

- V_{DS} 40 V
- I_D 60 A
- $R_{DS(ON)}$ (at $V_{GS}=10V$) <7.0 mohm
- $R_{DS(ON)}$ (at $V_{GS}=4.5V$) <9.5 mohm
- 100% EAS Tested
- 100% ∇V_{DS} Tested

General Description

- Trench Power LV MOSFET technology
- Excellent package for heat dissipation
- High density cell design for low $R_{DS(ON)}$
- Moisture Sensitivity Level 1
- Epoxy Meets UL 94 V-0 Flammability Rating
- Halogen Free

Applications

- High current load applications
- Load switching
- Hard switched and high frequency circuits
- Uninterruptible power supply

■ Absolute Maximum Ratings ($T_A=25^\circ C$ unless otherwise noted)

Parameter	Symbol	Limit	Unit
Drain-source Voltage	V_{DS}	40	V
Gate-source Voltage	V_{GS}	± 20	V
Drain Current	I_D	$T_C=25^\circ C$	60
		$T_C=100^\circ C$	38
Pulsed Drain Current ^A	I_{DM}	200	A
Total Power Dissipation	P_D	$T_C=25^\circ C$	44
		$T_C=100^\circ C$	17
Single Pulse Avalanche Energy ^B	E_{AS}	110	mJ
Thermal Resistance Junction-to-Case ^C	$R_{\theta JC}$	2.8	$^\circ C/W$
Junction and Storage Temperature Range	T_J, T_{STG}	-55~+150	$^\circ C$

■ Ordering Information (Example)

PREFERRED P/N	PACKING CODE	Marking	MINIMUM PACKAGE(pcs)	INNER BOX QUANTITY(pcs)	OUTER CARTON QUANTITY(pcs)	DELIVERY MODE
YJD60N04A	F1/F2	YJD60N04A	2500	/	25000	13" reel



YJD60N04A

■ Electrical Characteristics (T_J=25°C unless otherwise noted)

Parameter	Symbol	Conditions	Min	Typ	Max	Units
Static Parameter						
Drain-Source Breakdown Voltage	BV _{DSS}	V _{GS} = 0V, I _D =250μA	40			V
Zero Gate Voltage Drain Current	I _{DSS}	V _{DS} =40V, V _{GS} =0V	T _J =25°C		1	μA
			T _J =150°C		100	
Gate-Body Leakage Current	I _{GSS}	V _{GS} = ±20V, V _{DS} =0V			±100	nA
Gate Threshold Voltage	V _{GS(th)}	V _{DS} = V _{GS} , I _D = 250μA	1.0	1.5	2.5	V
Static Drain-Source On-Resistance	R _{DS(ON)}	V _{GS} = 10V, I _D =20A		5.4	7	mΩ
		V _{GS} = 4.5V, I _D =10A		6.8	9.5	
Diode Forward Voltage	V _{SD}	I _S =20A, V _{GS} =0V		0.8	1.2	V
Maximum Body-Diode Continuous Current	I _S				60	A
Dynamic Parameters						
Input Capacitance	C _{iss}	V _{DS} =20V, V _{GS} =0V, f=1MHZ		1860		pF
Output Capacitance	C _{oss}			256		
Reverse Transfer Capacitance	C _{rss}			205		
Switching Parameters						
Total Gate Charge	Q _g	V _{GS} =10V, V _{DS} =20V, I _D =20A		46.7		nC
Gate-Source Charge	Q _{gs}			8		
Gate-Drain Charge	Q _{gd}			11.6		
Reverse Recovery Charge	Q _{rr}	I _r =20A, di/dt=100A/us		2.3		ns
Reverse Recovery Time	t _{rr}			15		
Turn-on Delay Time	t _{D(on)}	V _{GS} =10V, V _{DD} =20V, I _D =2A, R _L =1Ω R _{GEN} =3Ω		10		ns
Turn-on Rise Time	t _r			21		
Turn-off Delay Time	t _{D(off)}			36		
Turn-off fall Time	t _f			25		

A. Pulse Test: Pulse Width ≤ 300us, Duty cycle ≤ 2%.

B. T_J=25°C, V_{DD}=38V, V_G=10V, L=0.5mH, I_{AS}=21A

C. R_{θJA} is the sum of the junction-to-case and case-to-ambient thermal resistance, where the case thermal reference is defined as the solder mounting surface of the drain pins. R_{θJC} is guaranteed by design, while R_{θJA} is determined by the board design. The maximum rating presented here is based on mounting on a 1 in 2 pad of 2oz copper.



■ Typical Performance Characteristics

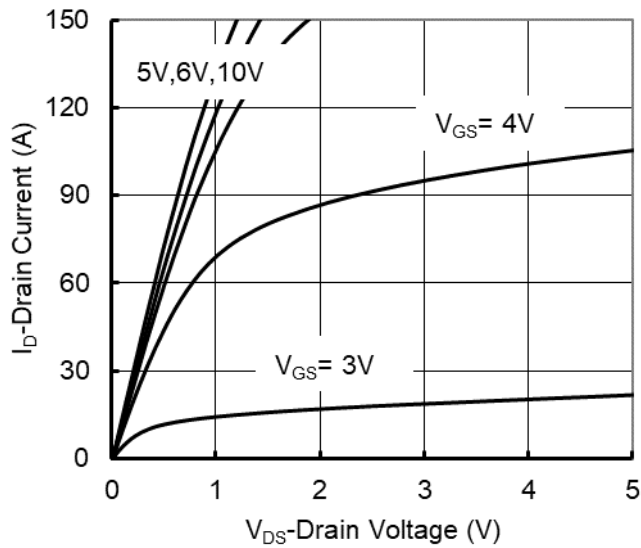

Figure 1. Output Characteristics

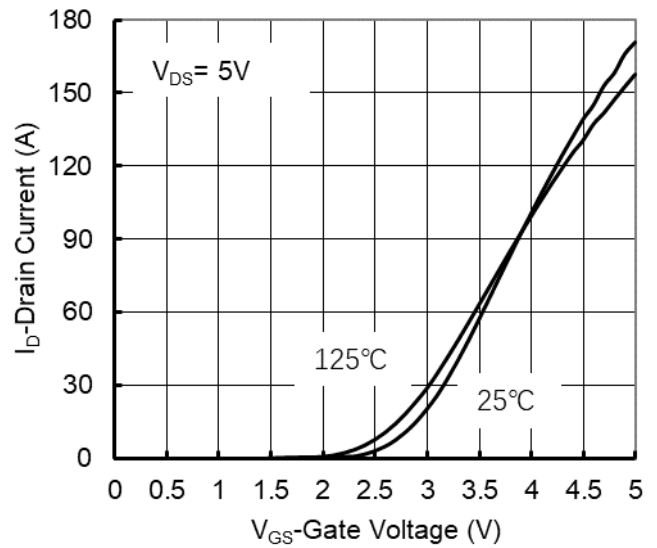

Figure 2. Transfer Characteristics

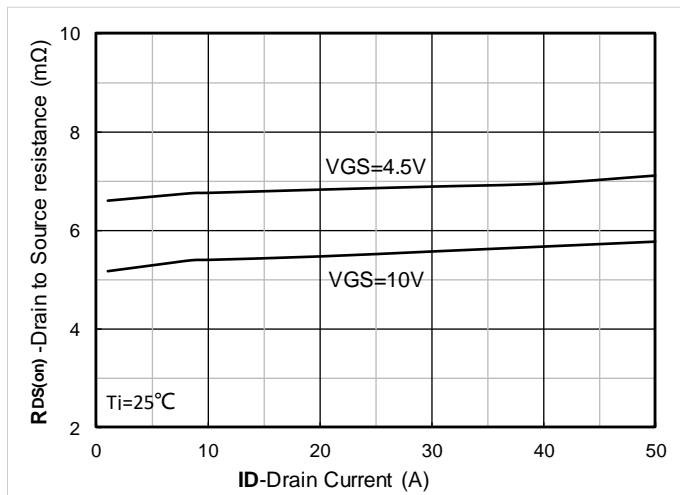

Figure 3. On-Resistance vs. Drain Current and Gate Voltage

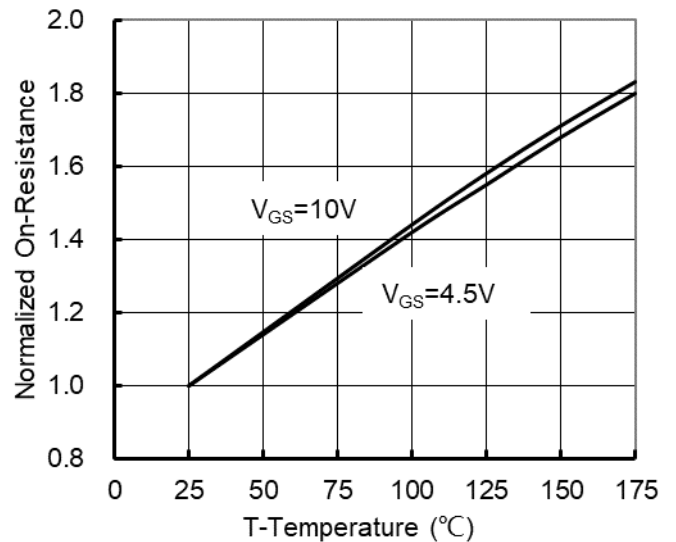

Figure 4. On-Resistance vs. Junction Temperature

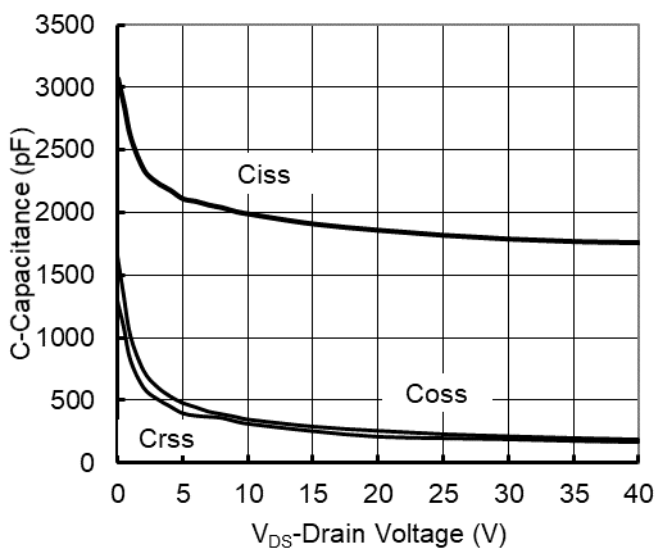

Figure 5. Capacitance Characteristics

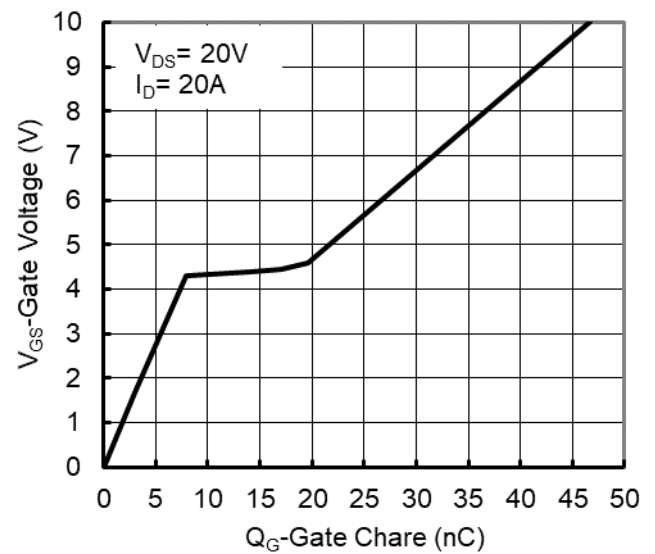

Figure 6. Gate Charge



YJD60N04A

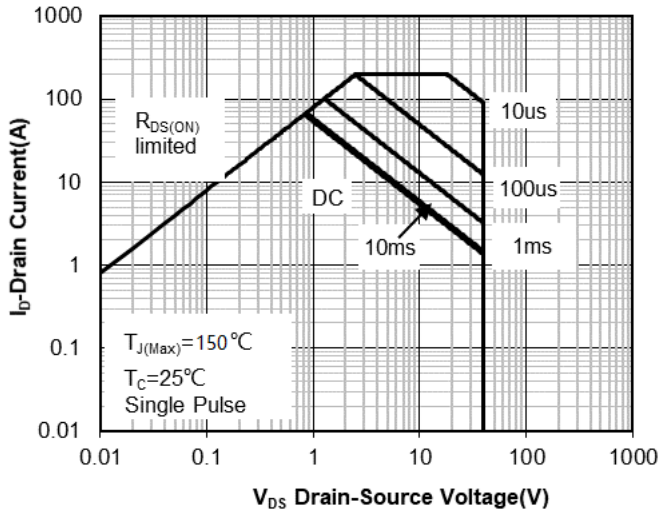

Figure 7. Safe Operation Area

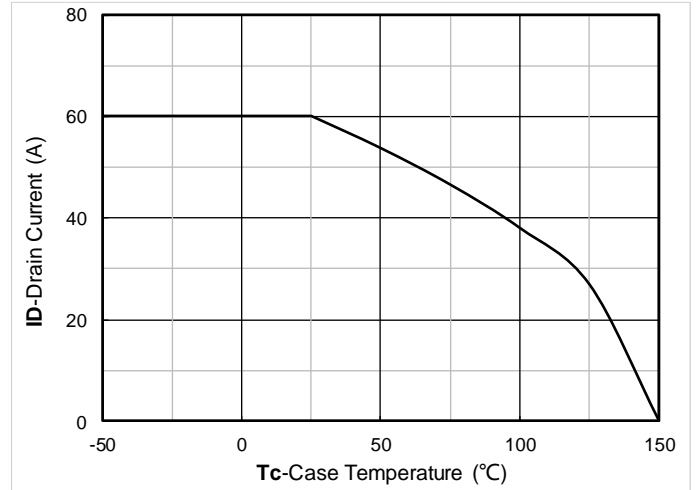

Figure 8. Maximum Continuous Drain Current vs Case Temperature

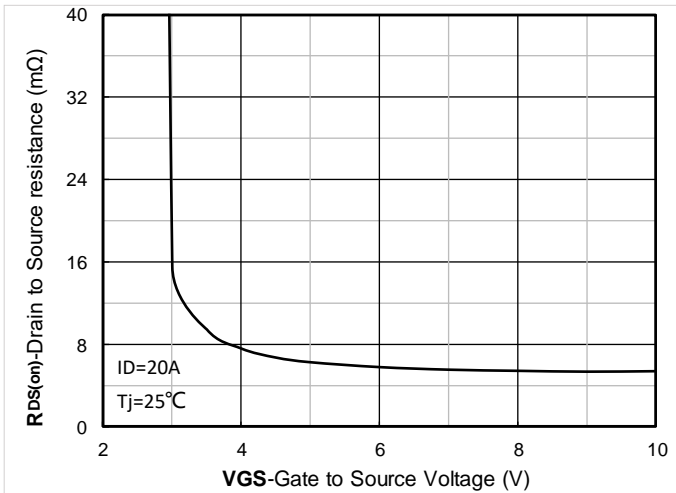

Figure 9. On-Resistance vs Gate to Source Voltage

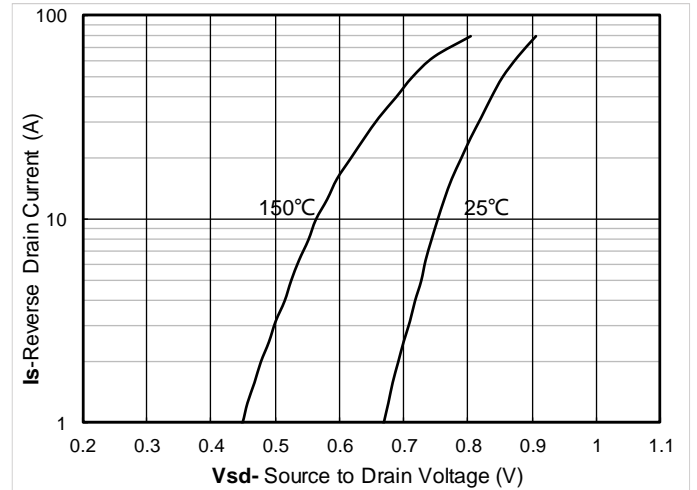

Figure 10. Forward characteristics of reverse diode

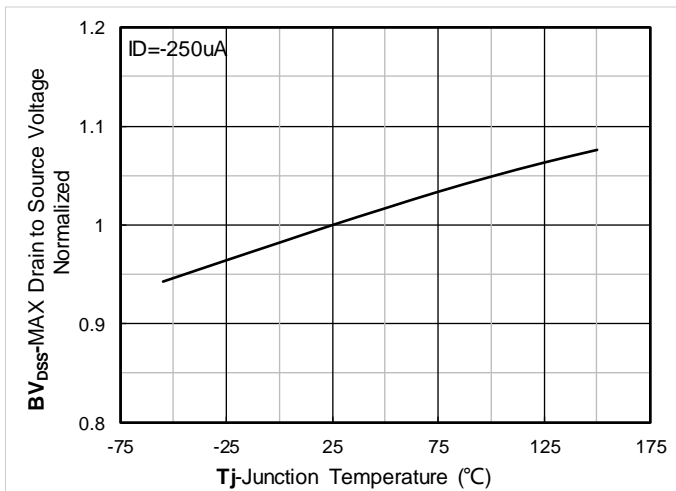

Figure 11. Normalized breakdown voltage

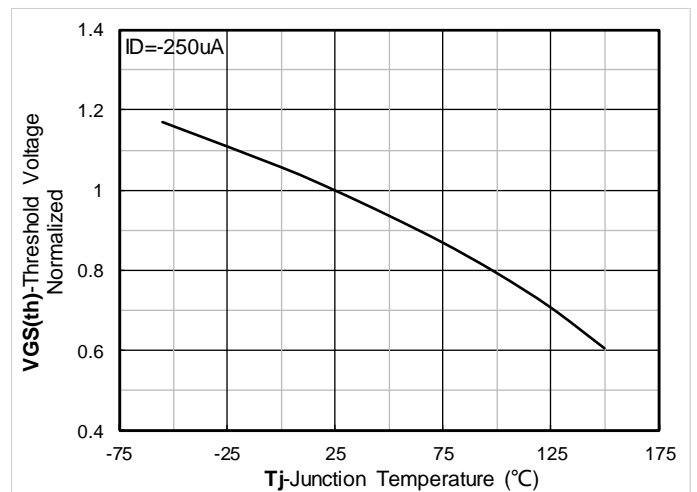

Figure 12. Normalized Threshold voltage



YJD60N04A

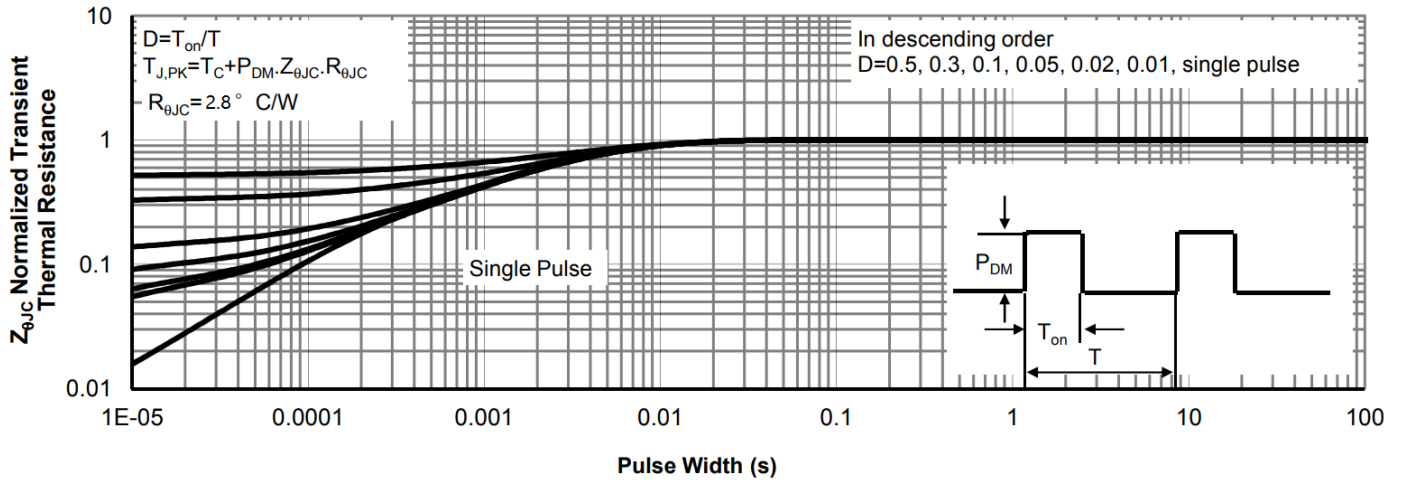
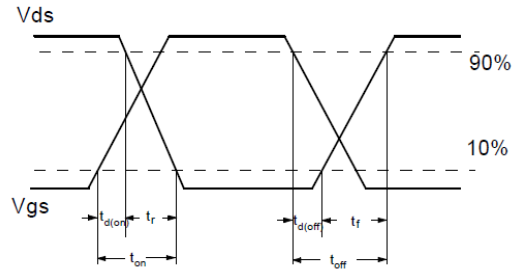
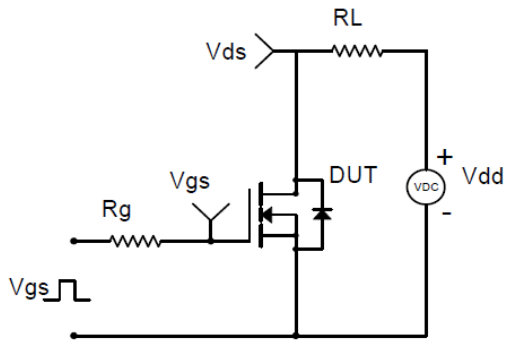
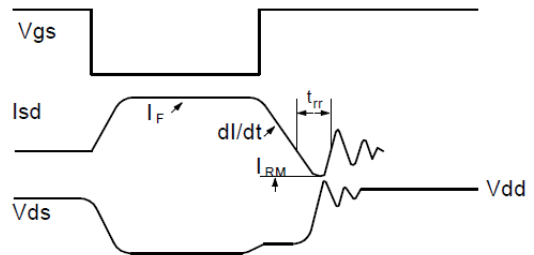
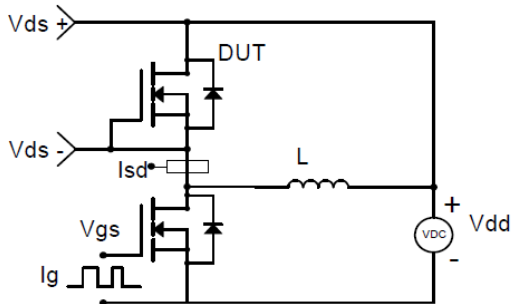

Figure 13. Normalized Maximum Transient Thermal Impedance



Resistive Switching Test Circuit & Waveforms



Diode Recovery Test Circuit & Waveforms

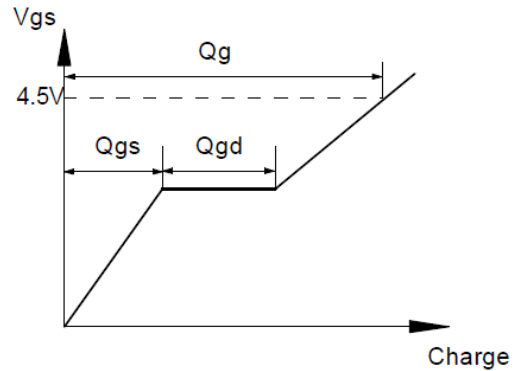
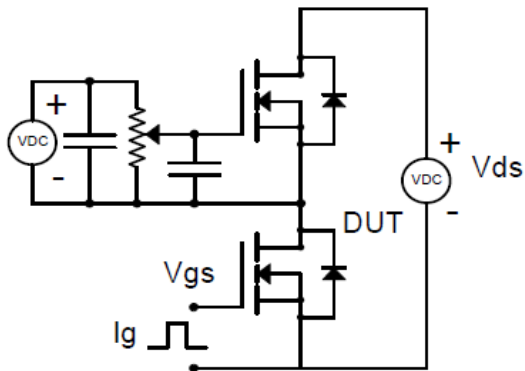

Gate Charge Test Circuit & Waveform

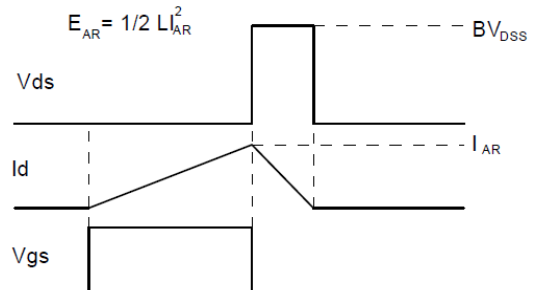
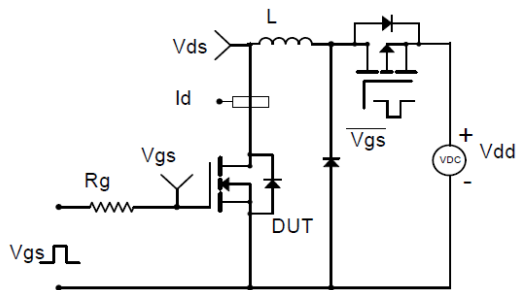

Unclamped Inductive Switching (UIS) Test Circuit & Waveforms



YJD60N04A

■ TO-252-B Package information

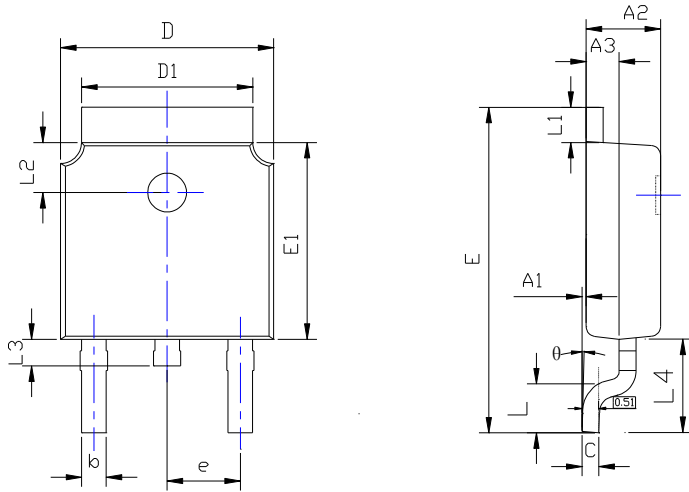

TOP VIEW

SIDE VIEW

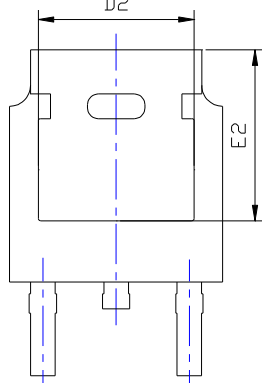

BOTTOM VIEW

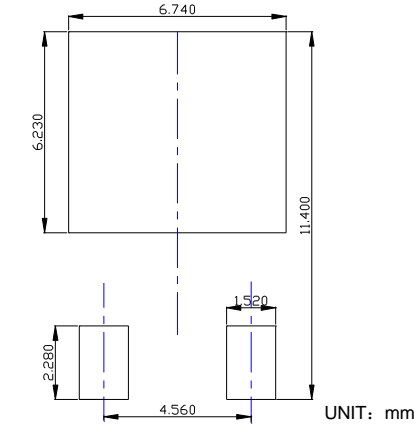

SUGGESTED SOLDER PAD LAYOUT

UNIT: mm

SYMBOL	DIMENSIONS					
	INCHES			Millimeter		
	MIN.	NDM.	MAX.	MIN.	NDM.	MAX.
A1	0.000	---	0.008	0.000	---	0.200
A2	0.087	0.091	0.094	2.200	2.300	2.400
A3	0.035	0.039	0.043	0.900	1.000	1.100
b	0.026	0.030	0.034	0.660	0.760	0.860
c	0.018	0.020	0.023	0.460	0.520	0.580
D	0.256	0.260	0.264	6.500	6.600	6.700
D1	0.203	0.209	0.215	5.150	5.300	5.450
D2	0.181	0.189	0.195	4.600	4.800	4.950
E	0.390	0.398	0.406	9.900	10.100	10.300
E1	0.236	0.240	0.244	6.000	6.100	6.200
E2	0.203	0.209	0.215	5.150	5.300	5.450
e	0.090BSC			2.286BSC		
L	0.049	0.059	0.069	1.250	1.500	1.750
L1	0.035	---	0.050	0.900	---	1.270
L2	0.055	---	0.075	1.400	---	1.900
L3	0.240	0.310	0.039	0.600	0.800	1.000
L4	0.114REF			2.900REF		
θ	0°	---	10°	0°	---	10°

NOTE:

- 1.PACKAGE BODY SIZES EXCLUDE MOLD FLASH AND GATE BURRS.
- 2.TOLERANCE 0.1mm UNLESS OTHERWISE SPECIFIED.
- 3.THE PAD LAYOUT IS FOR REFERENCE PURPOSES ONLY.



YJD60N04A

Disclaimer

The information presented in this document is for reference only. Yangzhou Yangjie Electronic Technology Co., Ltd. reserves the right to make changes without notice for the specification of the products displayed herein to improve reliability, function or design or otherwise.

The product listed herein is designed to be used with ordinary electronic equipment or devices, and not designed to be used with equipment or devices which require high level of reliability and the malfunction of which would directly endanger human life (such as medical instruments, transportation equipment, aerospace machinery, nuclear-reactor controllers, fuel controllers and other safety devices), Yangjie or anyone on its behalf, assumes no responsibility or liability for any damages resulting from such improper use of sale.

This publication supersedes & replaces all information previously supplied. For additional information, please visit our website [http:// www.21yangjie.com](http://www.21yangjie.com) , or consult your nearest Yangjie's sales office for further assistance.