



Thyristor Modules

VRRM / VDRM 800 to 1800V
ITAV 200A

Applications

- Power Converters
- Lighting Control
- DC Motor Control and Drives
- Heat and temperature control

Features

- International standard package
- High Surge Capability
- Glass passivated chip
- Simple Mounting
- Heat transfer through aluminum oxide DBC ceramic isolated metal baseplate
- UL recognized applied for file no. E360040

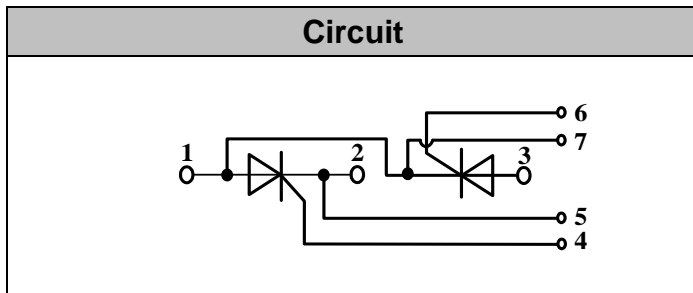

Module Type

TYPE	VRRM	VRSM
MT200C08T2	800V	900V
MT200C12T2	1200V	1300V
MT200C16T2	1600V	1700V
MT200C18T2	1800V	1900V

Maximum Ratings

Symbol	Conditions	Values	Units
ITAV	Sine 180°;Tc=85°C	200	A
ITSM	T _{VJ} =45°C t=10ms, sine	5500	A
	T _{VJ} =125°C t=10ms, sine	5000	
i ² t	T _{VJ} =45°C t=10ms, sine	151000	A ² s
	T _{VJ} =125°C t=10ms, sine	125000	
Visol	a.c.50HZ;r.m.s.;1min	3000	V
Tvj		-40 to 130	°C
Tstg		-40 to 125	°C
Mt	To terminals(M6)	5 ± 15%	Nm
Ms	To heat sink(M6)	5 ± 15%	Nm
di/dt	T _{VJ} = T _{VJM} , 2/3V _{DRM} ,I _G =500mA Tr<0.5us,tp>6us	200	A/us
dv/dt	T _J = T _{VJM} ,2/3V _{DRM} , linear voltage rise	1000	V/us
a	Maximum allowable acceleration	50	m/s ²
Weight	Module(Approximately)	165	g

Thermal Characteristics

Symbol	Conditions	Values	Units
Rth(j-c)	per thyristor / per module	0.16/0.08	°C/W
Rth(c-s)	per thyristor / per module	0.1/0.05	°C/W



Electrical Characteristics

Symbol	Conditions	Values			Units
		Min.	Typ.	Max.	
V_{TM}	$T=25^{\circ}C$ $I_{TM}=500A$			1.68	V
I_{RRM}/I_{DRM}	$T_{VJ}=T_{VJM}$, $V_R=V_{RRM}$, $V_D=V_{DRM}$			50	mA
V_{TO}	For power-loss calculations only ($T_{VJ}=125^{\circ}C$)			0.85	V
r_T	$T_{VJ}=T_{VJM}$			1.5	m Ω
V_{GT}	$T_{VJ}=25^{\circ}C$, $V_D=6V$			3	V
I_{GT}	$T_{VJ}=25^{\circ}C$, $V_D=6V$			200	mA
V_{GD}	$T_{VJ}=125^{\circ}C$, $V_D=2/3V_{DRM}$			0.25	V
I_{GD}	$T_{VJ}=125^{\circ}C$, $V_D=2/3V_{DRM}$			10	mA
I_L	$T_{VJ}=25^{\circ}C$, $R_G=33\ \Omega$		300	1000	mA
I_H	$T_{VJ}=25^{\circ}C$, $V_D=6V$		150	400	mA
tg d	$T_{VJ}=25^{\circ}C$, $I_G=1A$, $di_G/dt=1A/us$		1		us
tq	$T_{VJ}=T_{VJM}$		100		us



Performance Curves

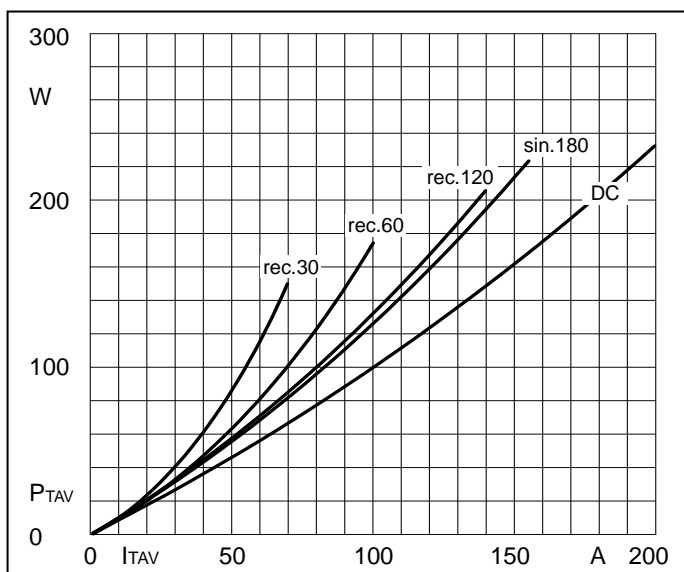

Fig1. Power dissipation

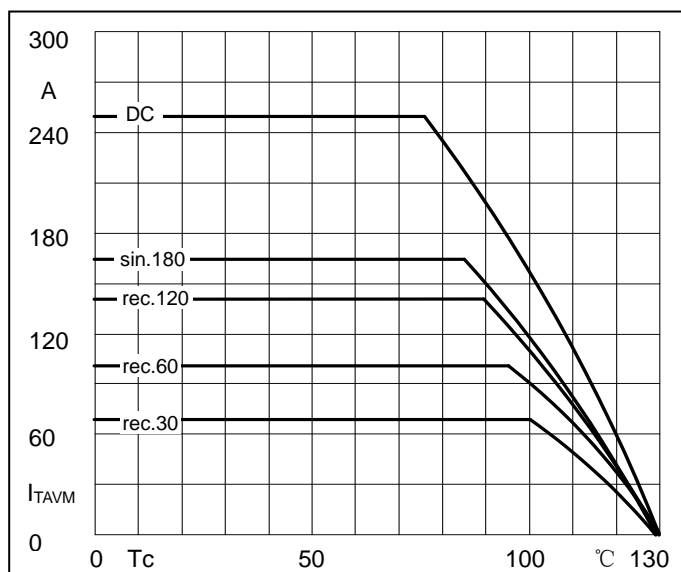

Fig2. Forward Current Derating Curve

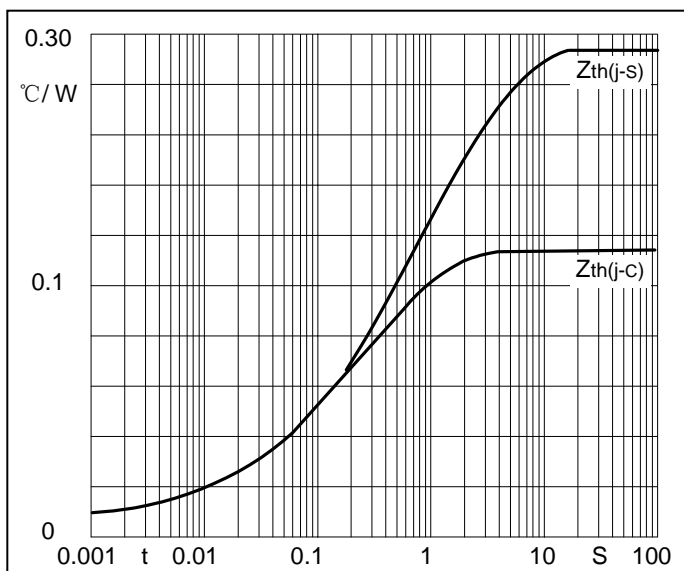

Fig3. Transient thermal impedance

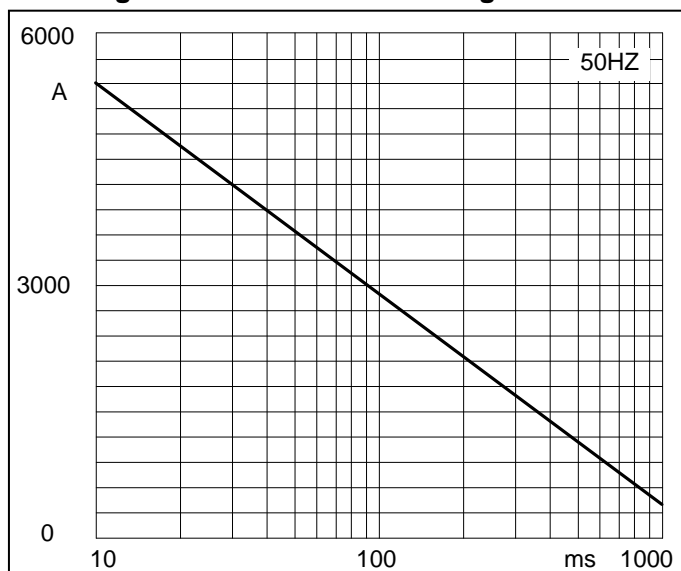

Fig4. Max Non-Repetitive Forward Surge Current

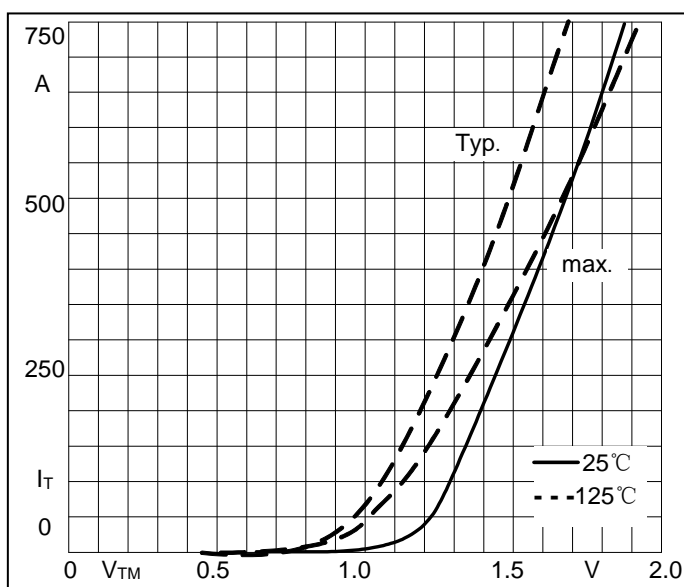

Fig5. Forward Characteristics

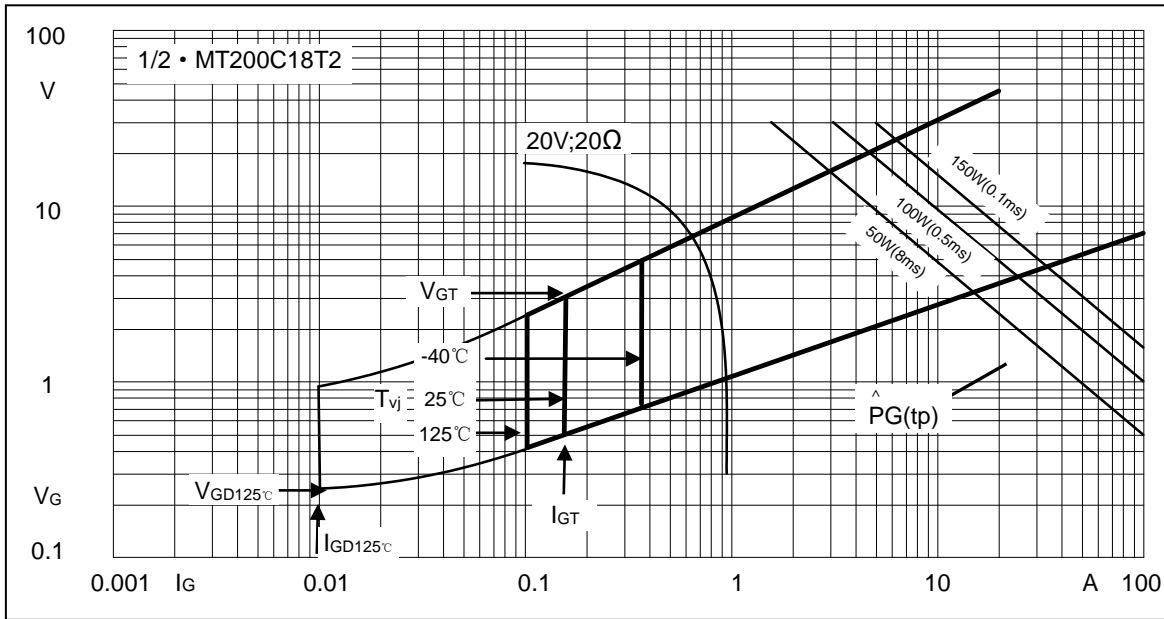
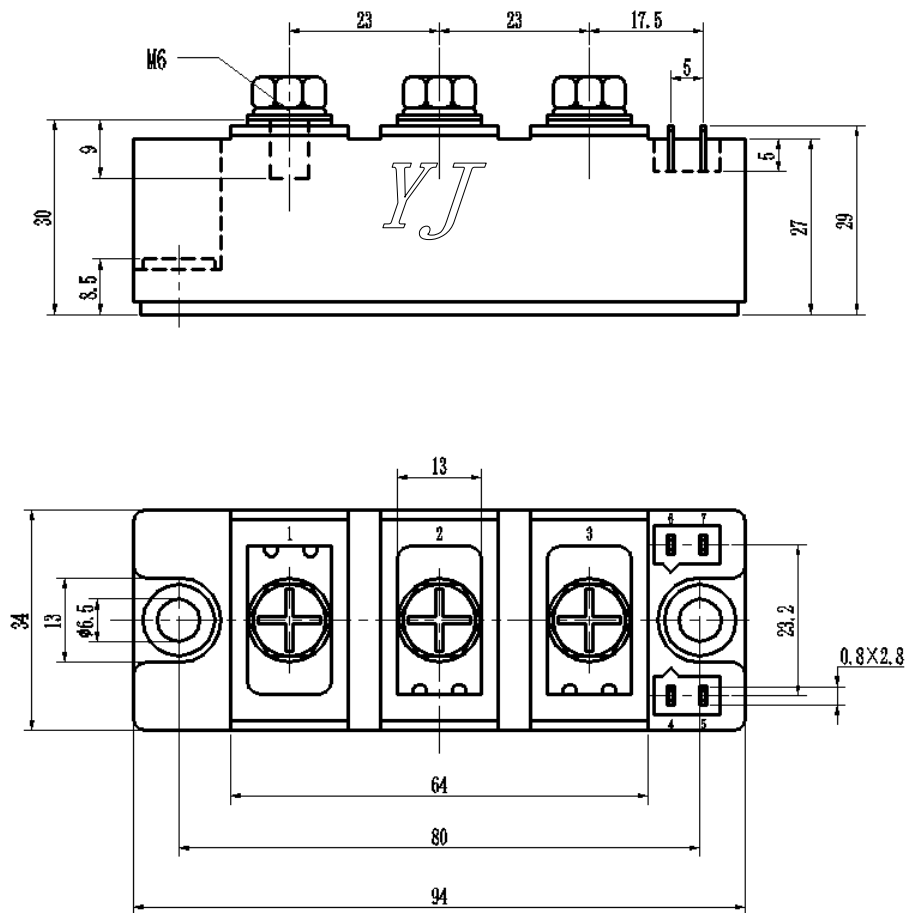

Fig6. Gate trigger Characteristics

Package Outline Information

CASE: T2



Dimensions in mm