

IGBT Discrete

V_{CE}	1200	V
I_C	75	A
$V_{CE(SAT)} I_C=75A$	1.85	V

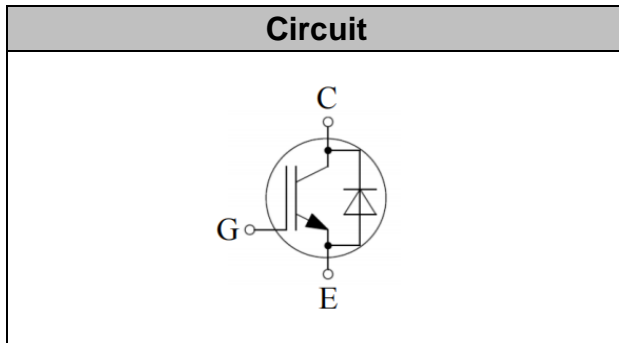

Applications

- Inverter for motor drive
- Three-level Solar String Inverter
- Motor controller

Features

- High breakdown voltage to 1200V for improved reliability
- Maximum junction temperature 175°C
- Positive temperature coefficient
- Including fast & soft recovery anti-parallel FWD
- High short circuit capability(10us)

Maximum Ratings

Parameter	Symbol	Value	Unit
Collector-Emitter Breakdown Voltage	V_{CE}	1200	V
DC Collector Current, limited by T_{jmax} $T_C=25^\circ C$ $T_C=100^\circ C$	I_C	150 75	A
Diode Forward Current, limited by T_{jmax} $T_C=25^\circ C$ $T_C=100^\circ C$	I_F	120 75	A
Continuous Gate-Emitter Voltage	V_{GE}	± 20	V
Transient Gate-Emitter Voltage ($t_p \leq 10\mu s, D < 0.010$)	V_{GE}	± 30	V
Turn off Safe Operating Area $V_{CE} \leq 1200V$, $T_j \leq 150^\circ C$		300	A
Pulsed Collector Current, $V_{GE}=15V$, t_p limited by T_{jmax}	I_{CM}	300	A
Diode Pulsed Current, t_p limited by T_{jmax}	I_{Fpuls}	300	A
Short Circuit Withstand Time, $V_{GE}=15V, V_{CC}=600V, V_{CEM} \leq 1200V$	T_{sc}	10	μs
Power Dissipation, $T_j=175^\circ C, T_C=25^\circ C$	P_{tot}	750	W



Operating Junction Temperature	T_j	-40...+175	°C
Storage Temperature	T_s	-55...+150	°C
Soldering Temperature, wave soldering 1.6mm (0.063in.) from case for 10s		260	°C

Electrical Characteristics of the IGBT ($T_j = 25^\circ\text{C}$ unless otherwise specified):

Parameter	Symbol	Conditions	Min.	Typ.	Max.	Unit
Static						
Collector-Emitter Breakdown Voltage	BV_{CES}	$V_{GE}=0V, I_C=250\mu A$	1200		-	V
Gate Threshold Voltage	$V_{GE(th)}$	$V_{GE}=V_{CE}, I_C=2.6mA$	5.2	5.8	6.5	V
Collector-Emitter Saturation Voltage	$V_{CE(sat)}$	$V_{GE}=15V, I_C=75A$ $T_j=25^\circ\text{C}$, $T_j=125^\circ\text{C}$ $T_j=150^\circ\text{C}$	1.50	1.85 2.20 2.30	2.20	V
Zero Gate Voltage Collector Current	I_{CES}	$V_{CE}=1200V, V_{GE}=0V$ $T_j=25^\circ\text{C}$, $T_j=150^\circ\text{C}$			0.25 5	mA
Gate-Emitter Leakage Current	I_{GES}	$V_{CE}=0V, V_{GE}=\pm 20V$			100	nA

Parameter	Symbol	Conditions	Min.	Typ.	Max.	Unit
Dynamic						
Input Capacitance	C_{ies}	$V_{CE}=25V, V_{GE}=0V,$ $f=1MHz$	-	5.29	-	nF
Reverse Transfer Capacitance	C_{res}		-	0.27	-	
Gate Charge	Q_G	$V_{CC}=960V, I_C=75A,$ $V_{GE}=15V$	-	0.55	-	uC

**Electrical Characteristics of the Diode** ($T_j = 25^\circ\text{C}$ unless otherwise specified):

Parameter	Symbol	Conditions	Min.	Typ.	Max.	Unit
Static						
Diode Forward Voltage	V_F	$I_F = 75\text{A}$ $T_j = 25^\circ\text{C}$, $T_j = 125^\circ\text{C}$ $T_j = 150^\circ\text{C}$		2.20 1.95 1.85	2.70	V

Switching Characteristic, Inductive Load

Parameter	Symbol	Conditions	Min.	Typ.	Max.	Unit
Dynamic , at $T_j = 25^\circ\text{C}$						
Turn-on Delay Time	$t_{d(on)}$	$V_{CC} = 600\text{V}$, $I_C = 75\text{A}$, $V_{GE} = -5\text{V} \sim 15\text{V}$, $R_g = 10\Omega$	-	20	-	ns
Rise Time	t_r		-	102	-	ns
Turn-on Energy	E_{on}		-	9.9	-	mJ
Turn-off Delay Time	$t_{d(off)}$		-	264	-	ns
Fall Time	t_f		-	128	-	ns
Turn-off Energy	E_{off}		-	3.9	-	mJ
Dynamic , at $T_j = 125^\circ\text{C}$						
Turn-on Delay Time	$t_{d(on)}$	$V_{CC} = 600\text{V}$, $I_C = 75\text{A}$, $V_{GE} = -5\text{V} \sim 15\text{V}$, $R_g = 10\Omega$	-	21	-	ns
Rise Time	t_r		-	93	-	ns
Turn-on Energy	E_{on}		-	10.1	-	mJ
Turn-off Delay Time	$t_{d(off)}$		-	325	-	ns
Fall Time	t_f		-	212	-	ns
Turn-off Energy	E_{off}		-	5.8	-	mJ
Dynamic , at $T_j = 150^\circ\text{C}$						
Turn-on Delay Time	$t_{d(on)}$	$V_{CC} = 600\text{V}$, $I_C = 75\text{A}$, $V_{GE} = -5\text{V} \sim 15\text{V}$, $R_g = 10\Omega$	-	21	-	ns
Rise Time	t_r		-	91	-	ns
Turn-on Energy	E_{on}		-	10.2	-	mJ
Turn-off Delay Time	$t_{d(off)}$		-	357	-	ns
Fall Time	t_f		-	264	-	ns
Turn-off Energy	E_{off}		-	6.6	-	mJ



Electrical Characteristics of the DIODE

Parameter	Symbol	Conditions	Min.	Typ.	Max.	Unit
Dynamic , at T_j= 25°C						
Reverse Recovery Current	I _{rr}	I _F =75A, V _R =600V, di/dt= -500A/μs	-	9	-	A
Diode reverse recovery time	t _{rr}		-	268	-	ns
Reverse Recovery Charge	Q _{rr}		-	3.42	-	uC
Reverse Recovery Energy	E _{rec}		-	1.75	-	mJ
Dynamic , at T_j= 125°C						
Reverse Recovery Current	I _{rr}	I _F =75A, V _R =600V, di/dt= -500A/μs	-	12	-	A
Diode reverse recovery time	t _{rr}		-	337	-	ns
Reverse Recovery Charge	Q _{rr}		-	6.58	-	uC
Reverse Recovery Energy	E _{rec}		-	3.18	-	mJ
Dynamic , at T_j= 150°C						
Reverse Recovery Current	I _{rr}	I _F =75A, V _R =600V, di/dt= -500A/μs	-	14	-	A
Diode reverse recovery time	t _{rr}		-	375	-	ns
Reverse Recovery Charge	Q _{rr}		-	9.45	-	uC
Reverse Recovery Energy	E _{rec}		-	3.73	-	mJ

Thermal Resistance

Parameter	Symbol	Max. Value	Unit
IGBT Thermal Resistance, Junction - Case	R _{th(j-c)}	0.20	K/W
Diode Thermal Resistance, Junction - Case	R _{th(j-c)}	0.35	K/W
Thermal Resistance, Junction - Ambient	R _{th(j-a)}	40	K/W

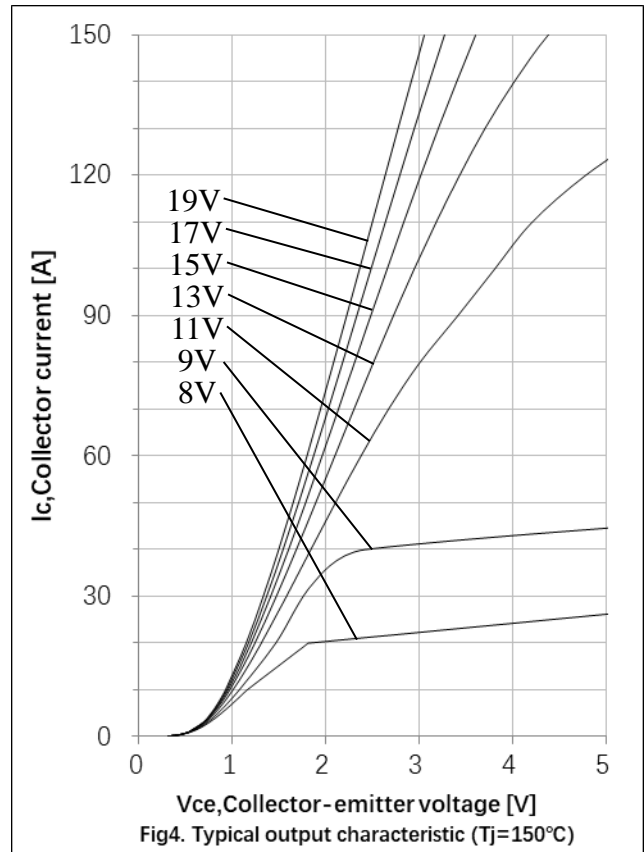
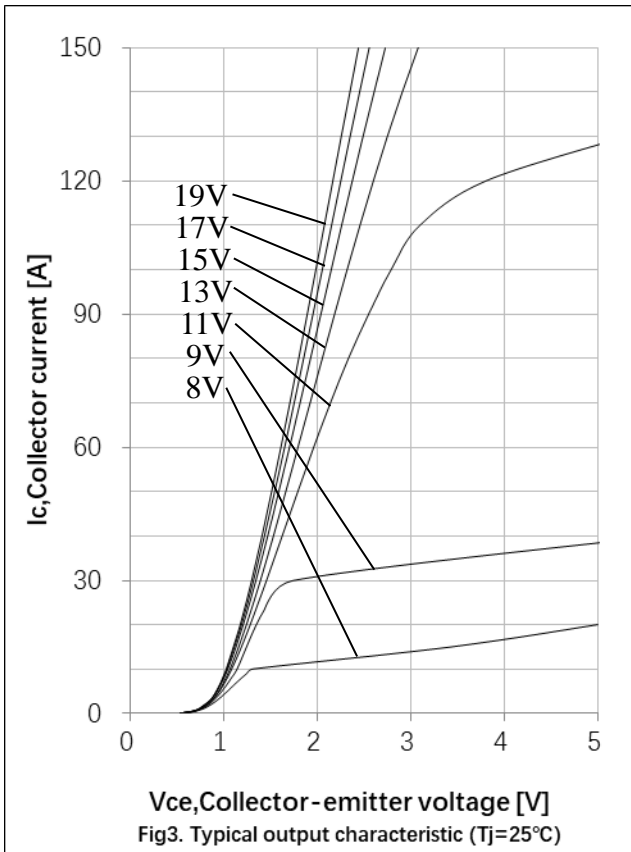
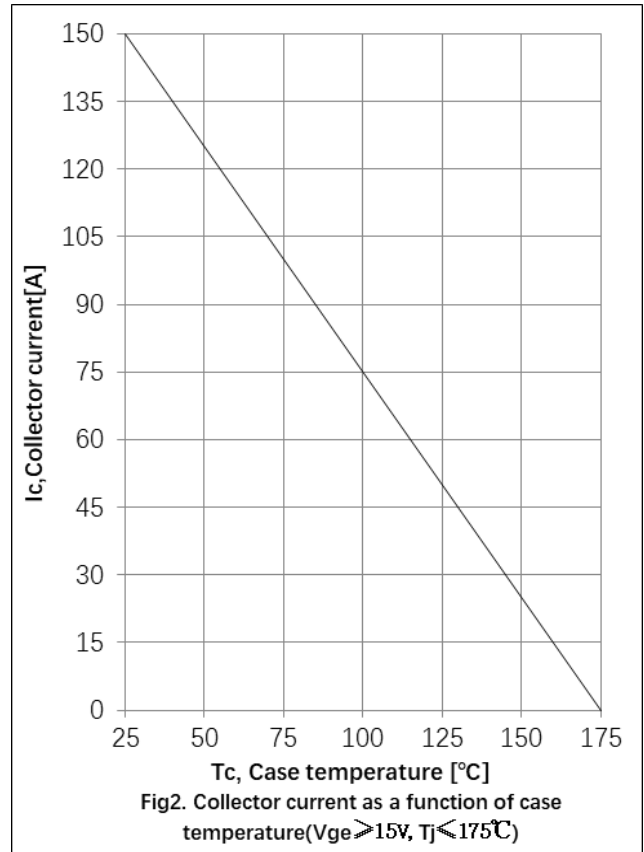
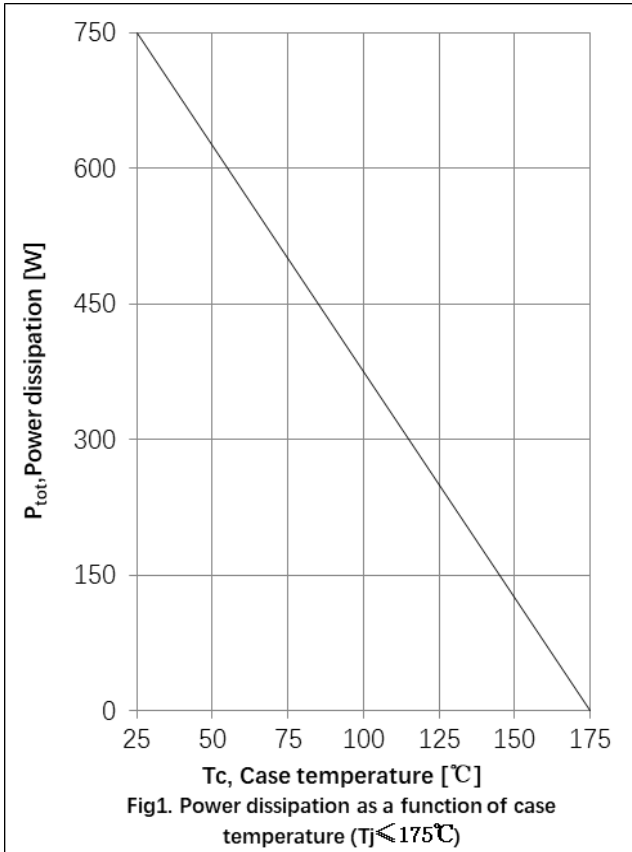

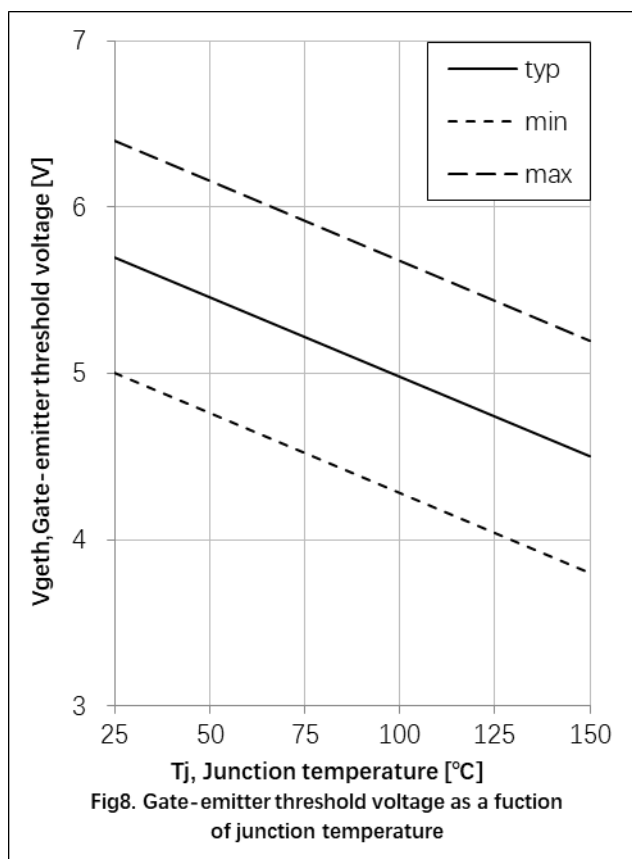
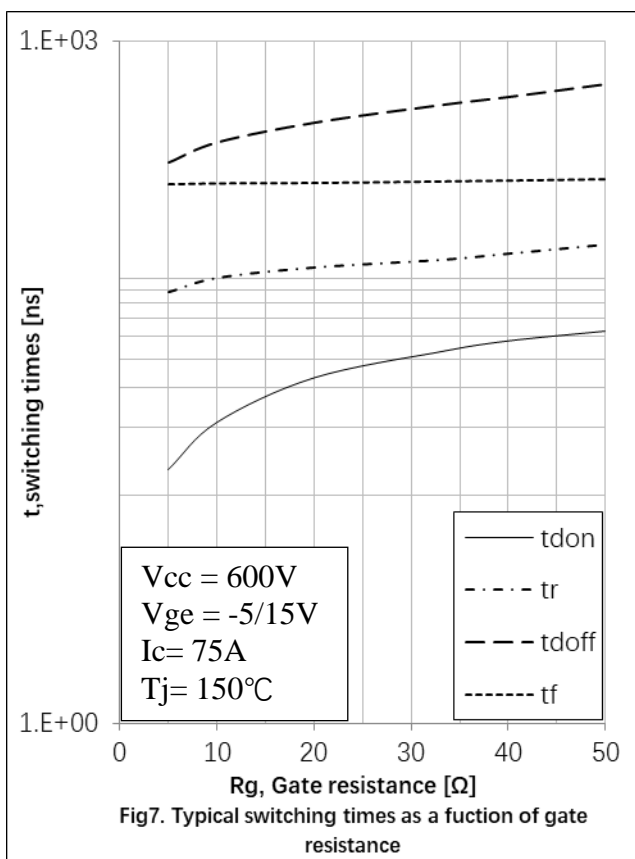
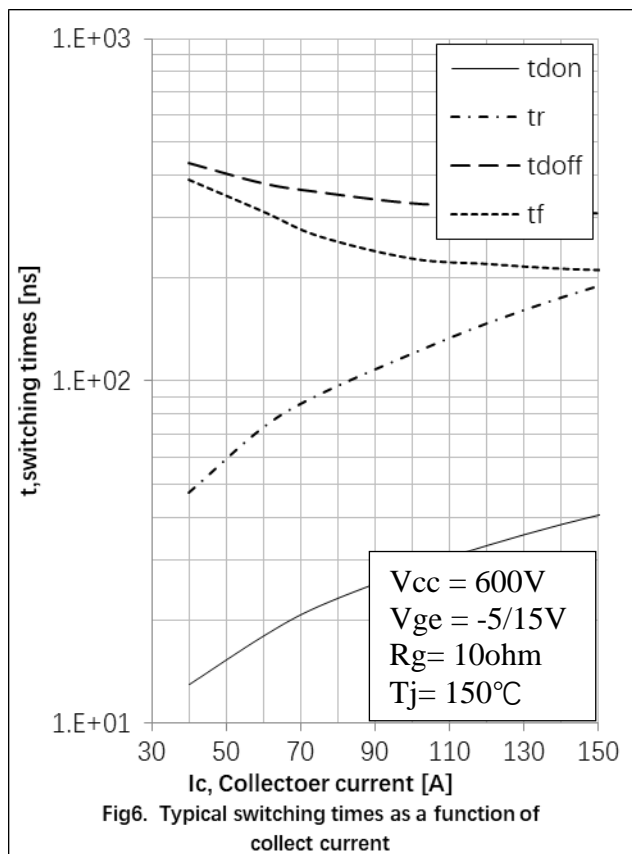
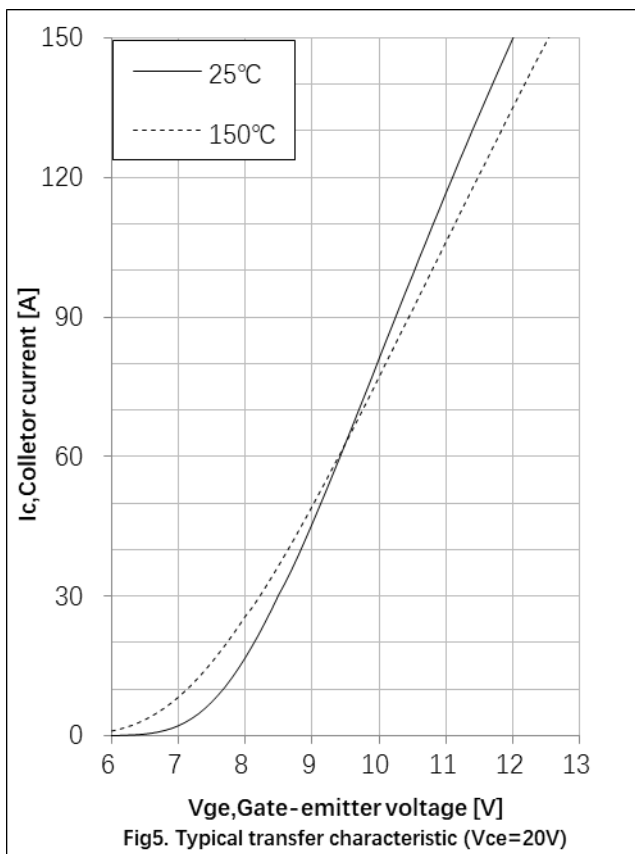

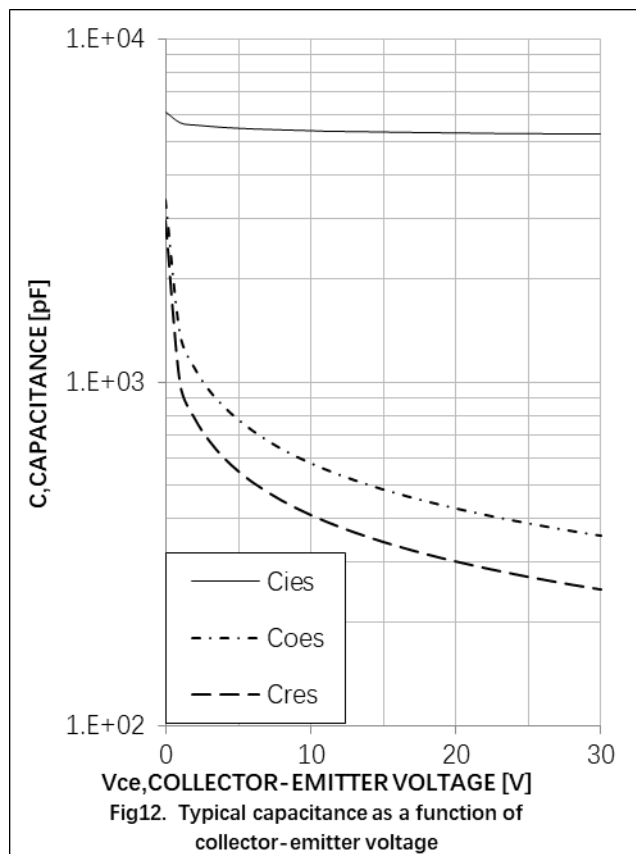
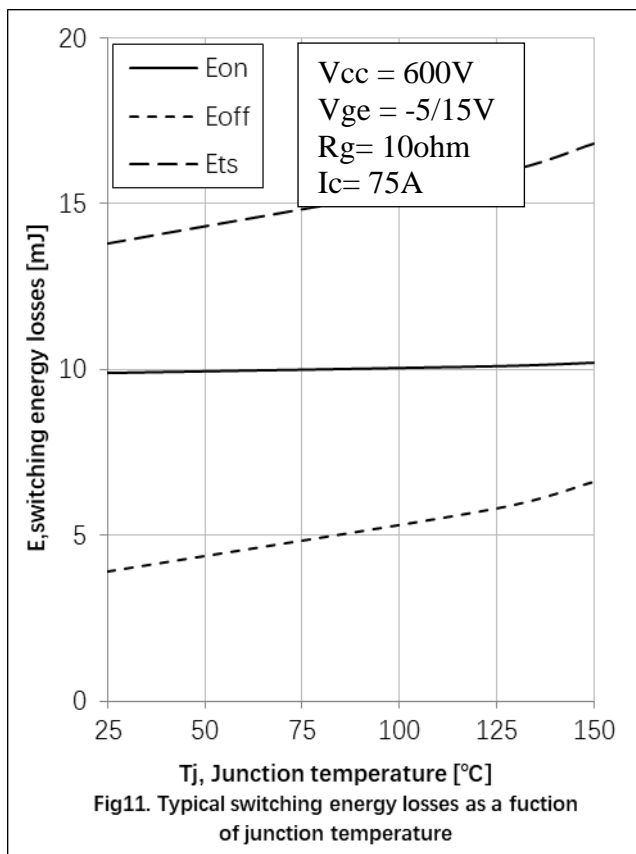
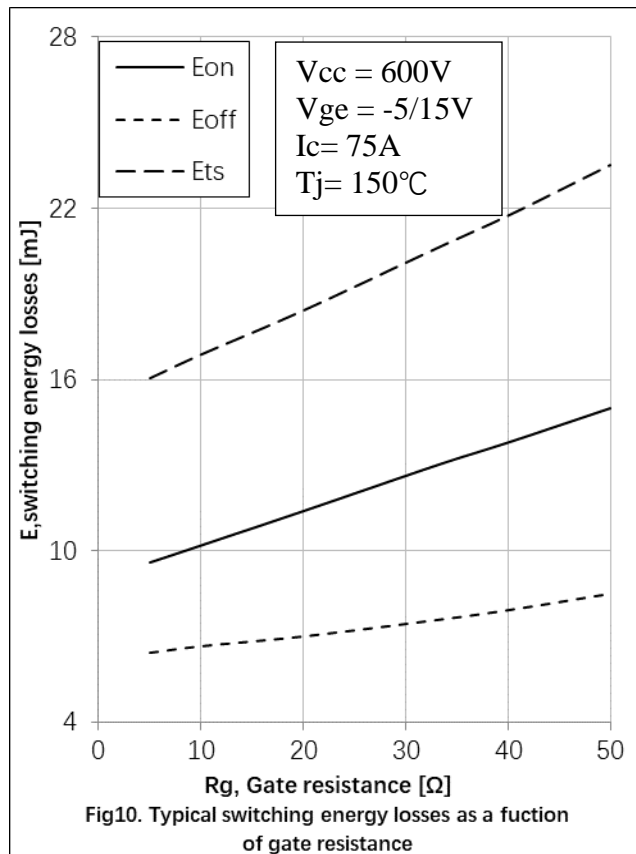
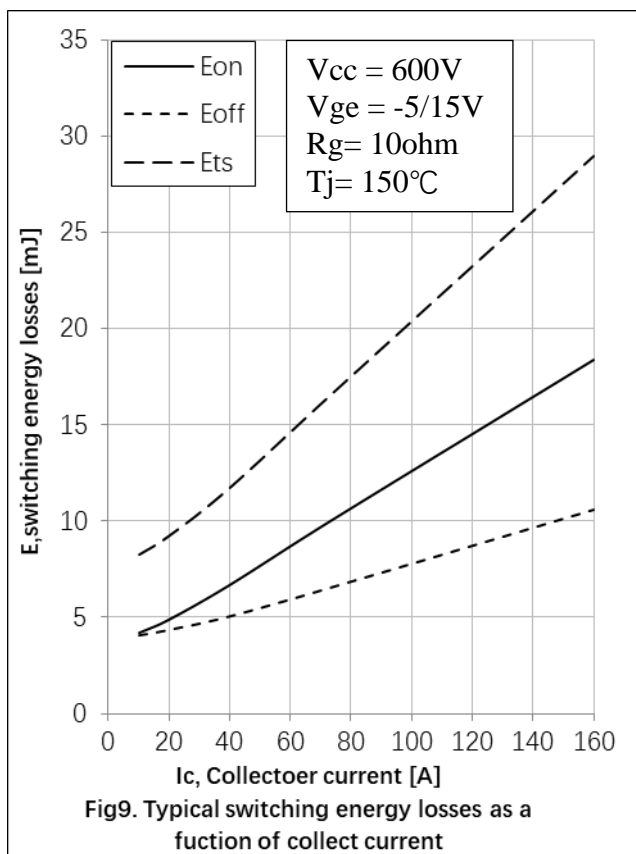

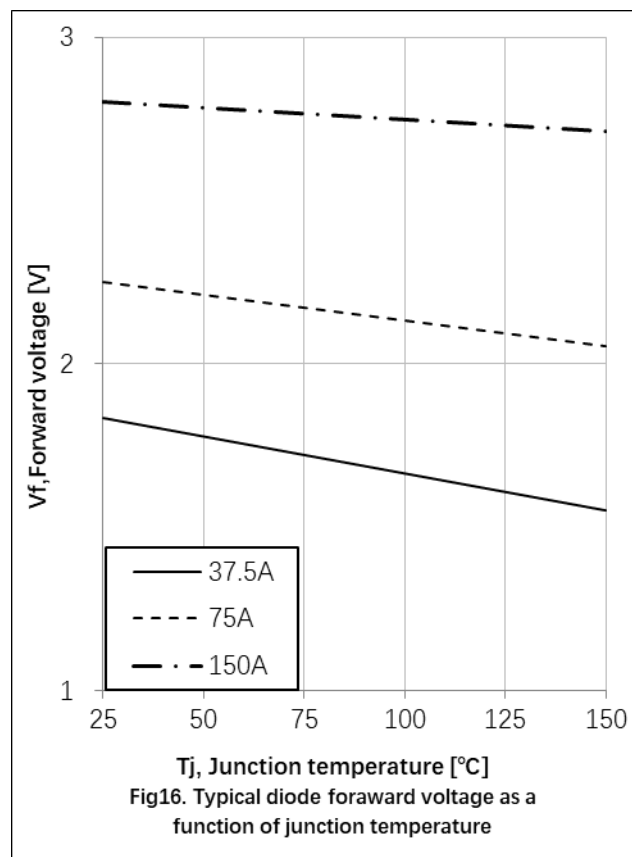
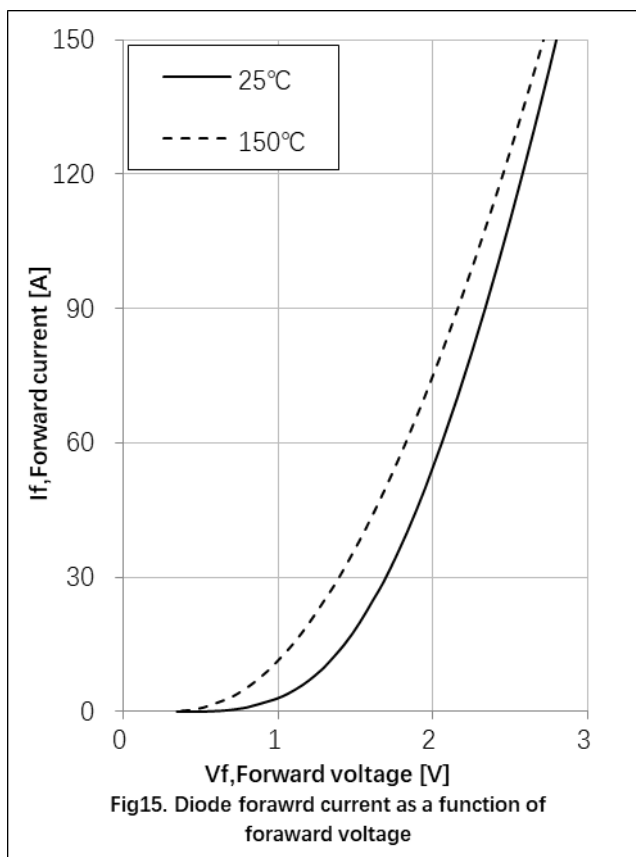
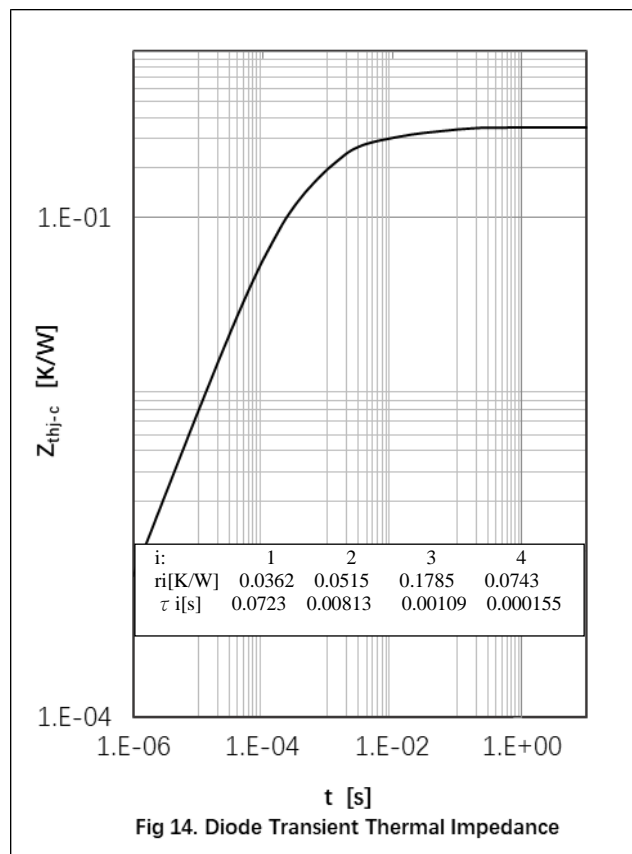
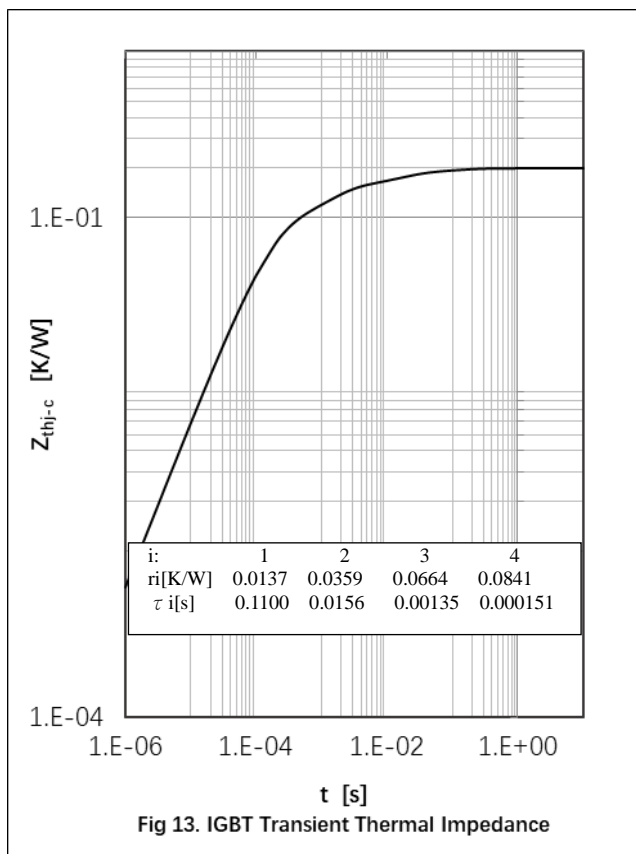

Circuit Diagram

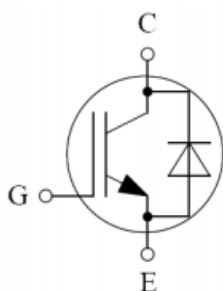

● Package Outline Information

CASE: TO 247plus

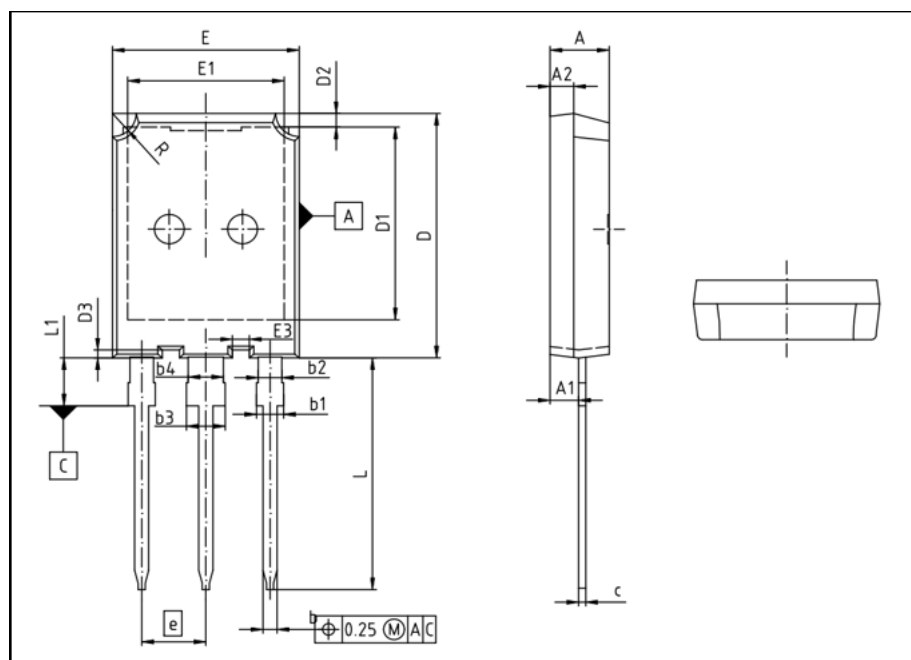

DIM	MILLIMETERS	
	MIN	MAX
A	4.90	5.10
A1	2.31	2.51
A2	1.90	2.10
b	1.16	1.26
b1	1.86	2.16
b2	1.96	2.06
c	0.58	0.64
D	20.90	21.10
D1	16.25	16.85
D2	1.05	1.35
D3	0.58	0.78
E	15.70	15.90
E1	13.10	13.50
E3	1.35	1.55
e	5.44(BSC)	
L	19.78	20.08
L1	4.03	4.23
R	1.90	2.10